



⚠ Read this manual carefully before operating this vehicle.

OWNER'S MANUAL *GDR155-A*



BG3-F8199-30

⚠ Read this manual carefully before operating this vehicle. This manual should stay with this vehicle if it is sold.

EAU46091

⚠ 在使用这电单车以前，请充分使用这小手册。这手册须付与电单车一起。

EAU46091

⚠ Baca buku panduan dengan teliti sebelum mengendalikan motosikal ini. Buku panduan diberi bersama dengan pembelian motosikal.

EAU46091

Welcome to the Yamaha world of motorcycling!

As the owner of the GDR155-A, you are benefiting from Yamaha's vast experience and newest technology regarding the design and manufacture of high-quality products, which have earned Yamaha a reputation for dependability.

Please take the time to read this manual thoroughly, so as to enjoy all advantages of your GDR155-A. The Owner's Manual does not only instruct you in how to operate, inspect and maintain your scooter, but also in how to safeguard yourself and others from trouble and injury.

In addition, the many tips given in this manual will help keep your scooter in the best possible condition. If you have any further questions, do not hesitate to contact your Yamaha dealer.

The Yamaha team wishes you many safe and pleasant rides. So, remember to put safety first!



Yamaha continually seeks advancements in product design and quality. Therefore, while this manual contains the most current product information available at the time of printing, there may be minor discrepancies between your scooter and this manual. If there is any question concerning this manual, please consult a Yamaha dealer.

WARNING

Please read this manual carefully and completely before operating this scooter.

Important manual information

Particularly important information is distinguished in this manual by the following notations:

	This is the safety alert symbol. It is used to alert you to potential personal injury hazards. Obey all safety messages that follow this symbol to avoid possible injury or death.
 WARNING	A WARNING indicates a hazardous situation which, if not avoided, could result in death or serious injury.
NOTICE	A NOTICE indicates special precautions that must be taken to avoid damage to the vehicle or other property.
TIP	A TIP provides key information to make procedures easier or clearer.

*Product and specifications are subject to change without notice.

EAU0012

**GDR155-A
OWNER'S MANUAL**
©2017 by Yamaha Motor Co., Ltd.
1st edition, June 2017
All rights reserved.
Any reprinting or unauthorized use
without the written permission of
Yamaha Motor Co., Ltd.
is expressly prohibited.
Printed in Malaysia

Table of contents

Location of important labels	1-1	Instrument and control functions .	6-1	Tips for reducing fuel consumption	8-3
Safety information	2-1	Indicator lights and warning lights	6-1	Engine break-in.....	8-4
Further safe-riding points	2-5	Multi-function meter unit.....	6-3	Parking.....	8-4
Helmets	2-6	Handlebar switches	6-8	General note	8-6
Description	3-1	Front brake lever	6-9	Periodic maintenance and adjustment	9-1
Left view	3-1	Rear brake lever	6-9	Owner's tool kit.....	9-1
Right view.....	3-2	ABS (for ABS models)	6-9	Periodic maintenance chart for the emission control system	9-2
Controls and instruments	3-3	Fuel tank cap	6-10	General maintenance and lubrication chart	9-3
Smart key system (GDR155-A)	4-1	Fuel	6-11	Removing and installing panels..	9-7
Smart key system.....	4-1	Fuel tank overflow hose.....	6-12	Checking the spark plug.....	9-8
Operating range of the smart key system.....	4-2	Catalytic converter	6-12	Engine oil and oil strainer	9-10
Handling of the smart key and mechanical keys	4-3	Seat	6-13	Final transmission oil	9-12
Smart key	4-5	Helmet holders.....	6-13	Coolant	9-13
Replacing the smart key battery..	4-6	Storage compartments	6-14	Air filter and V-belt case air filter elements.....	9-15
Main switch	4-7	Sidestand.....	6-15	Checking the throttle grip free play.....	9-17
Fuel tank cap lid opening and closing.....	4-10	Ignition circuit cut-off system ...	6-15	Valve clearance.....	9-17
Seat opening and closing.....	4-11	Auxiliary DC jack	6-17	Tires	9-18
Stop and Start System (GDR155-A)	5-1	For your safety – pre-operation checks	7-1	Cast wheels	9-19
Stop and Start System.....	5-1	Operation and important riding points.....	8-1	Checking the front brake lever free play.....	9-20
Stop and Start System operation.....	5-1	Starting the engine.....	8-1	Adjusting the rear brake lever free play.....	9-20
		Starting off	8-2	Checking the front brake pads and rear brake shoes	9-21
		Acceleration and deceleration ..	8-3		
		Braking.....	8-3		

Table of contents

Checking the brake fluid level	9-22	Care	10-1
Changing the brake fluid	9-23	Storage	10-3
Checking the V-belt.....	9-23	Specifications	11-1
Checking and lubricating the cables.....	9-23	Consumer information	12-1
Checking and lubricating the throttle grip and cable.....	9-24	Identification numbers	12-1
Lubricating the front and rear brake levers.....	9-24	Index	13-1
Checking and lubricating the centerstand and sidestand	9-25		
Checking the front fork.....	9-25		
Checking the steering	9-26		
Checking the wheel bearings	9-26		
Battery.....	9-27		
Replacing the fuses.....	9-28		
Headlight	9-30		
Replacing an auxiliary light bulb.	9-30		
Tail/brake light	9-31		
Replacing a front turn signal light bulb	9-31		
Replacing a rear turn signal light bulb	9-32		
Replacing the license plate light bulb	9-33		
Troubleshooting	9-33		
Troubleshooting charts	9-36		
Emergency mode (GDR155-A) ..	9-38		
Scooter care and storage	10-1		
Matte color caution	10-1		

Location of important labels

EAU10385

1

Read and understand all of the labels on your vehicle. They contain important information for safe and proper operation of your vehicle. Never remove any labels from your vehicle. If a label becomes difficult to read or comes off, a replacement label is available from your Yamaha dealer.

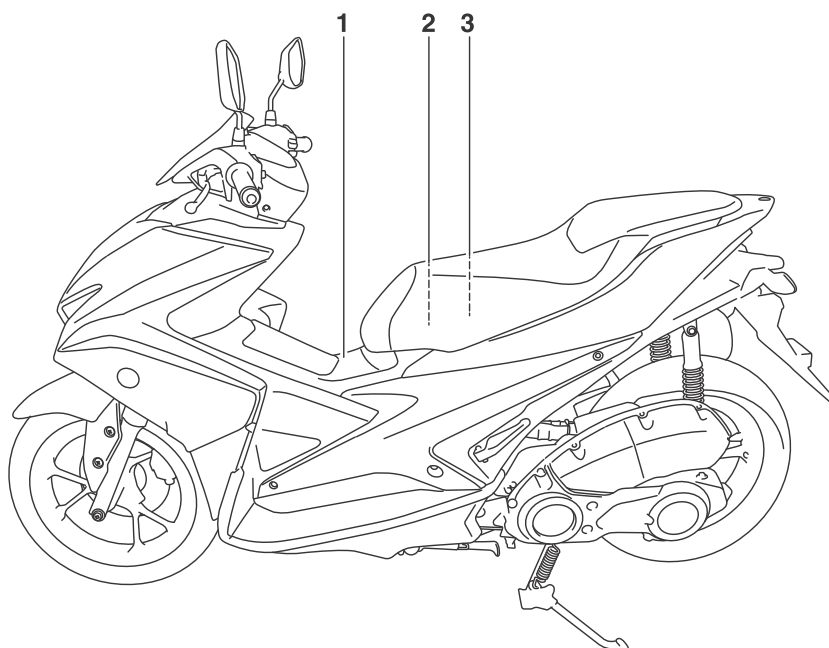

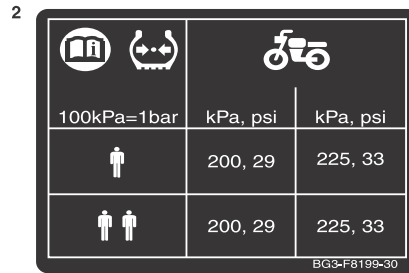

1-2

Safety information

EAU1026B

2

Be a Responsible Owner

As the vehicle's owner, you are responsible for the safe and proper operation of your scooter.

Scooters are single-track vehicles.

Their safe use and operation are dependent upon the use of proper riding techniques as well as the expertise of the operator. Every operator should know the following requirements before riding this scooter.

He or she should:

- Obtain thorough instructions from a competent source on all aspects of scooter operation.
- Observe the warnings and maintenance requirements in this Owner's Manual.
- Obtain qualified training in safe and proper riding techniques.
- Obtain professional technical service as indicated in this Owner's Manual and/or when made necessary by mechanical conditions.

- Never operate a scooter without proper training or instruction. Take a training course. Beginners should receive training from a certified instructor. Contact an authorized scooter dealer to find out about the training courses nearest you.

Safe Riding

Perform the pre-operation checks each time you use the vehicle to make sure it is in safe operating condition. Failure to inspect or maintain the vehicle properly increases the possibility of an accident or equipment damage. See page 7-1 for a list of pre-operation checks.

- This scooter is designed to carry the operator and a passenger.
- The failure of motorists to detect and recognize scooters in traffic is the predominating cause of automobile/scooter accidents. Many accidents have been caused by an automobile driver who did not see the scooter. Making yourself

conspicuous appears to be very effective in reducing the chance of this type of accident.

Therefore:

- Wear a brightly colored jacket.
- Use extra caution when you are approaching and passing through intersections, since intersections are the most likely places for scooter accidents to occur.
- Ride where other motorists can see you. Avoid riding in another motorist's blind spot.
- Never maintain a scooter without proper knowledge. Contact an authorized scooter dealer to inform you on basic scooter maintenance. Certain maintenance can only be carried out by certified staff.

2-1

- Many accidents involve inexperienced operators. In fact, many operators who have been involved in accidents do not even have a current driver's license.
 - Make sure that you are qualified and that you only lend your scooter to other qualified operators.
 - Know your skills and limits. Staying within your limits may help you to avoid an accident.
 - We recommend that you practice riding your scooter where there is no traffic until you have become thoroughly familiar with the scooter and all of its controls.
- Many accidents have been caused by error of the scooter operator. A typical error made by the operator is veering wide on a turn due to excessive speed or undercornering (insufficient lean angle for the speed).
 - Always obey the speed limit and never travel faster than warranted by road and traffic conditions.
- Always signal before turning or changing lanes. Make sure that other motorists can see you.
- The posture of the operator and passenger is important for proper control.
 - The operator should keep both hands on the handlebar and both feet on the operator footrests during operation to maintain control of the scooter.
 - The passenger should always hold onto the operator, the seat strap or grab bar, if equipped, with both hands and keep both feet on the passenger footrests. Never carry a passenger unless he or she can firmly place both feet on the passenger footrests.
- Never ride under the influence of alcohol or other drugs.
- This scooter is designed for on-road use only. It is not suitable for off-road use.

2-2

Protective Apparel

The majority of fatalities from scooter accidents are the result of head injuries. The use of a safety helmet is the single most critical factor in the prevention or reduction of head injuries.

- Always wear an approved helmet.
- Wear a face shield or goggles. Wind in your unprotected eyes could contribute to an impairment of vision that could delay seeing a hazard.
- The use of a jacket, substantial shoes, trousers, gloves, etc., is effective in preventing or reducing abrasions or lacerations.
- Never wear loose-fitting clothes, otherwise they could catch on the control levers or wheels and cause injury or an accident.
- Always wear protective clothing that covers your legs, ankles, and feet. The engine or exhaust system become very hot during or after operation and can cause burns.
- A passenger should also observe the above precautions.

 **Safety information**

Avoid Carbon Monoxide Poisoning

All engine exhaust contains carbon monoxide, a deadly gas. Breathing carbon monoxide can cause headaches, dizziness, drowsiness, nausea, confusion, and eventually death.

Carbon Monoxide is a colorless, odorless, tasteless gas which may be present even if you do not see or smell any engine exhaust. Deadly levels of carbon monoxide can collect rapidly and you can quickly be overcome and unable to save yourself. Also, deadly levels of carbon monoxide can linger for hours or days in enclosed or poorly ventilated areas. If you experience any symptoms of carbon monoxide poisoning, leave the area immediately, get fresh air, and SEEK MEDICAL TREATMENT.

- Do not run engine indoors. Even if you try to ventilate engine exhaust with fans or open windows and doors, carbon monoxide can rapidly reach dangerous levels.
- Do not run engine in poorly ventilated or partially enclosed areas such as barns, garages, or carports.

- Do not run engine outdoors where engine exhaust can be drawn into a building through openings such as windows and doors.

Loading

Adding accessories or cargo to your scooter can adversely affect stability and handling if the weight distribution of the scooter is changed. To avoid the possibility of an accident, use extreme caution when adding cargo or accessories to your scooter. Use extra care when riding a scooter that has added cargo or accessories. Here, along with the information about accessories below, are some general guidelines to follow if loading cargo to your scooter:

The total weight of the operator, passenger, accessories and cargo must not exceed the maximum load limit.

Operation of an overloaded vehicle could cause an accident.

Maximum load:

153 kg (337 lb) (GDR155-A)

When loading within this weight limit, keep the following in mind:

- Cargo and accessory weight should be kept as low and close to the scooter as possible. Securely pack your heaviest items as close to the center of the vehicle as possible and make sure to distribute the weight as evenly as possible on both sides of the scooter to minimize imbalance or instability.
- Shifting weights can create a sudden imbalance. Make sure that accessories and cargo are securely attached to the scooter before riding. Check accessory mounts and cargo restraints frequently.
- Properly adjust the suspension for your load (suspension-adjustable models only), and check the condition and pressure of your tires.
- Never attach any large or heavy items to the handlebar, front fork, or front fender. Such items can create unstable handling or a slow steering response.

- **This vehicle is not designed to pull a trailer or to be attached to a sidecar.**

Genuine Yamaha Accessories

Choosing accessories for your vehicle is an important decision. Genuine Yamaha accessories, which are available only from a Yamaha dealer, have been designed, tested, and approved by Yamaha for use on your vehicle. Many companies with no connection to Yamaha manufacture parts and accessories or offer other modifications for Yamaha vehicles. Yamaha is not in a position to test the products that these aftermarket companies produce. Therefore, Yamaha can neither endorse nor recommend the use of accessories not sold by Yamaha or modifications not specifically recommended by Yamaha, even if sold and installed by a Yamaha dealer.

Aftermarket Parts, Accessories, and Modifications

While you may find aftermarket products similar in design and quality to genuine Yamaha accessories, recog-

nize that some aftermarket accessories or modifications are not suitable because of potential safety hazards to you or others. Installing aftermarket products or having other modifications performed to your vehicle that change any of the vehicle's design or operation characteristics can put you and others at greater risk of serious injury or death. You are responsible for injuries related to changes in the vehicle.

Keep the following guidelines in mind, as well as those provided under "Loading" when mounting accessories.

- Never install accessories or carry cargo that would impair the performance of your scooter. Carefully inspect the accessory before using it to make sure that it does not in any way reduce ground clearance or cornering clearance, limit suspension travel, steering travel or control operation, or obscure lights or reflectors.
- Accessories fitted to the handlebar or the front fork area can create instability due to improper weight distribution or aerodynamic changes. If accessories

are added to the handlebar or front fork area, they must be as lightweight as possible and should be kept to a minimum.

- Bulky or large accessories may seriously affect the stability of the scooter due to aerodynamic effects. Wind may attempt to lift the scooter, or the scooter may become unstable in cross winds. These accessories may also cause instability when passing or being passed by large vehicles.
- Certain accessories can displace the operator from his or her normal riding position. This improper position limits the freedom of movement of the operator and may limit control ability, therefore, such accessories are not recommended.
- Use caution when adding electrical accessories. If electrical accessories exceed the capacity of the scooter's electrical system, an electric failure could result, which could cause a dangerous loss of lights or engine power.

Safety information

Aftermarket Tires and Rims

The tires and rims that came with your scooter were designed to match the performance capabilities and to provide the best combination of handling, braking, and comfort. Other tires, rims, sizes, and combinations may not be appropriate. Refer to page 9-18 for tire specifications and more information on replacing your tires.

Transporting the Scooter

Be sure to observe following instructions before transporting the scooter in another vehicle.

- Remove all loose items from the scooter.
- Point the front wheel straight ahead on the trailer or in the truck bed, and choke it in a rail to prevent movement.
- Secure the scooter with tie-downs or suitable straps that are attached to solid parts of the scooter, such as the frame or upper front fork triple clamp (and not, for example, to rubber-mounted handlebars or turn signals, or parts that could break). Choose the lo-

cation for the straps carefully so the straps will not rub against painted surfaces during transport.

- The suspension should be compressed somewhat by the tie-downs, if possible, so that the scooter will not bounce excessively during transport.

Further safe-riding points

EAU57600

- Be sure to signal clearly when making turns.
- Braking can be extremely difficult on a wet road. Avoid hard braking, because the scooter could slide. Apply the brakes slowly when stopping on a wet surface.
- Slow down as you approach a corner or turn. Once you have completed a turn, accelerate slowly.
- Be careful when passing parked cars. A driver might not see you and open a door in your path.
- Railroad crossings, streetcar rails, iron plates on road construction sites, and manhole covers become extremely slippery when wet. Slow down and cross them with caution. Keep the scooter upright, otherwise it could slide out from under you.
- The brake pads or linings could get wet when you wash the scooter. After washing the scooter, check the brakes before riding.

- Always wear a helmet, gloves, trousers (tapered around the cuff and ankle so they do not flap), and a brightly colored jacket.
- Do not carry too much luggage on the scooter. An overloaded scooter is unstable. Use a strong cord to secure any luggage to the carrier (if equipped). A loose load will affect the stability of the scooter and could divert your attention from the road. (See page 2-3.)

Helmets

EAUN0532

Operating this vehicle without an approved motorcycle helmet increases your chances of a severe head injury or death in the event of an accident. The majority of fatalities from motorcycle or scooter accidents are the result of head injuries. The use of a safety helmet is the single most critical factor in the prevention or reduction of head injuries.

Always select an approved motorcycle helmet

Pay attention to the following when choosing a motorcycle helmet.

- The helmet must meet the safety standard “TCVN”.
- The helmet size must match the size of the rider’s head.
- Never subject a helmet to heavy shocks.

Wearing the helmet correctly

Always connect the chin strap. In the case of an accident, the helmet has a much less chance of coming off if the chin strap is connected.

Correct usage



ZAUU0003

Wrong usage



ZAUU0007

⚠ Safety information

Types of helmets and their usage

- Full-type: use only for riding at low to mid-range speeds



ZAUU0005

- Full-face-type: use for riding at mid-range to high speeds



ZAUU0006

Left view

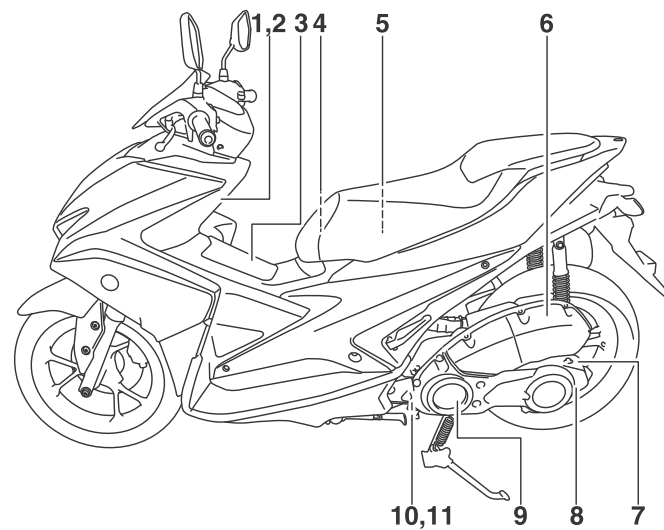

1. Front storage compartment (page 6-16)
2. Auxiliary DC jack (page 6-20)
3. Fuel tank cap (page 6-12)
4. Owner's tool kit (page 9-1)
5. Rear storage compartment (page 6-16)
6. Air filter element (page 9-15)
7. Final transmission oil filler cap (page 9-12)
8. Final transmission oil drain bolt (page 9-12)

9. V-belt case air filter element (page 9-15)
10. Engine oil drain bolt A (page 9-10)
11. Engine oil drain bolt B (page 9-10)

3-1

3

Description

Right view

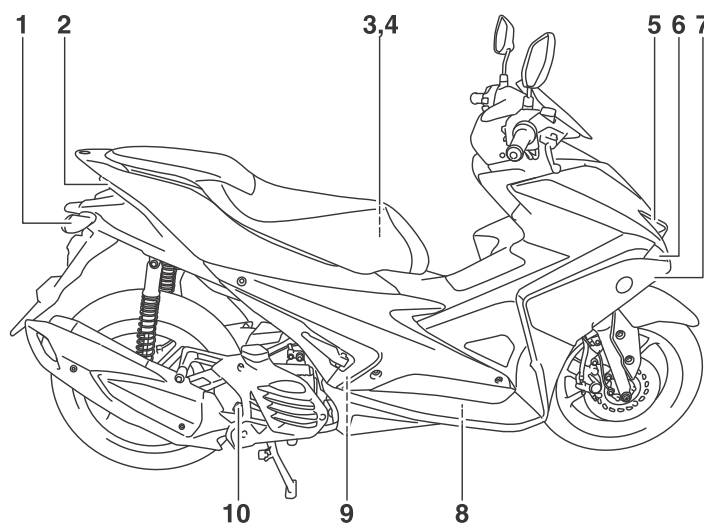

1. Rear turn signal light (page 9-32)
2. Tail/brake light (page 9-31)
3. Battery (page 9-27)
4. Fuse box (page 9-28)
5. Headlight (page 9-30)
6. Auxiliary light (page 9-30)
7. Front turn signal light (page 9-31)
8. Coolant reservoir (page 9-13)

9. Spark plug (page 9-8)
10. Engine oil filler cap (page 9-10)

3-2

3

Description

GDR155-A

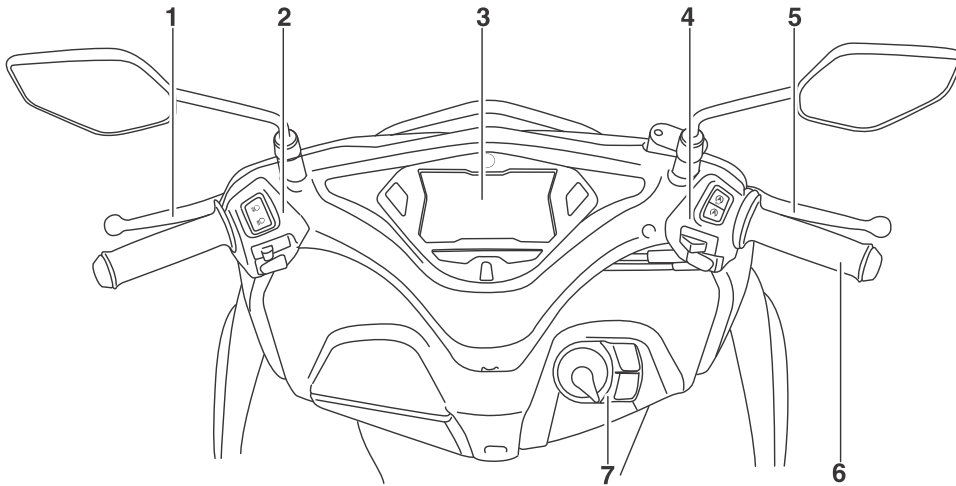

- 1. Rear brake lever (page 6-11)
- 2. Left handlebar switches (page 6-10)
- 3. Multi-function meter unit (page 6-5)
- 4. Right handlebar switches (page 6-10)
- 5. Front brake lever (page 6-11)
- 6. Throttle grip (page 9-17)
- 7. Main switch/steering lock (page 6-1)

3

3-3

Smart key system (GDR155-A)

Smart key system

EAU76442

The smart key system enables you to operate the vehicle without using a mechanical key. In addition, there is an answer-back function to help you locate the vehicle in a parking lot. (See page 4-5.)

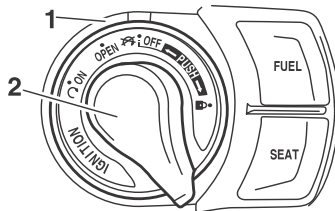

- 1. Main switch
- 2. Main switch knob

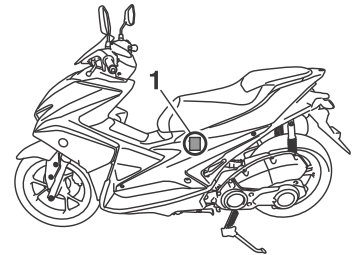

- 1. Vehicle mounted antenna

ECA15763

4

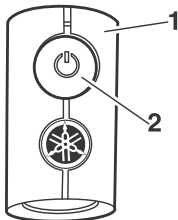

- 1. Smart key
- 2. Smart key button

EWA14704

WARNING

- Keep implanted pacemakers or cardiac defibrillators, as well as other electric medical devices away from the vehicle mounted antenna (see illustration).
- Radio waves transmitted by the antenna may affect the operation of such devices when close by.
- If you have an electric medical device, consult a doctor or the device manufacturer before using this vehicle.

NOTICE

The smart key system uses weak radio waves. The smart key system may not work in the following situations.

- The smart key is placed in a location exposed to strong radio waves or other electromagnetic noise
- There are facilities nearby that are emitting strong radio waves (TV or radio towers, power plants, broadcasting stations, airports, etc.)

4-1

Smart key system (GDR155-A)

- You are carrying or using communication equipment such as radios or mobile phones in close proximity of the smart key
- The smart key is in contact with or covered by a metallic object
- Other vehicles equipped with a smart key system are nearby

In such situations, move the smart key to another location and perform the operation again. If it still does not work, use the mechanical key to carry out the operation in emergency mode (See page 9-38).

TIP

To preserve vehicle battery power, the smart key system turns off approximately 9 days after the vehicle was last used (the answer-back function is disabled). In this situation, simply push the main switch knob to turn the smart key system back on.

Operating range of the smart key system

EAU76450

The operating range of the smart key system is about 80 cm (31.5 in) from the main switch.

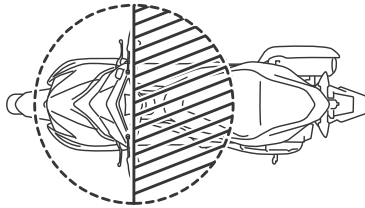
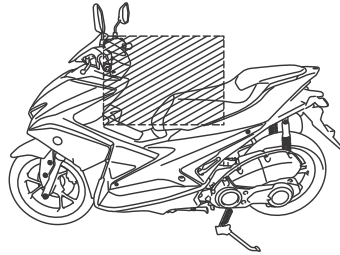

TIP

- As the smart key system uses weak radio waves, the operating range may be affected by the surrounding environment.
- When the battery of the smart key is discharged, the smart key may not work or its operating range may become very small.
- If the smart key is turned off, the vehicle will not recognize the smart key even if it is within operating range. If the smart key system does not operate, see page 4-5 and confirm that the smart key is turned on.
- Placing the smart key in the front or rear storage compartment may block communication between the smart key and the vehicle. If the rear storage compartment is locked with the smart key inside, the smart key system may be disabled. The smart key should always be carried with you.

4

4-2

Smart key system (GDR155-A)

- When leaving the vehicle, make sure you lock the steering and take the smart key with you. It is recommended that you turn the smart key off.

Handling of the smart key and mechanical keys

EAU76460

EWA17952

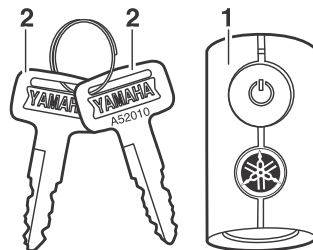

1. Smart key
2. Mechanical key

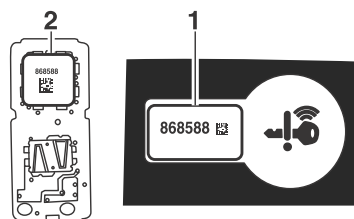

1. Identification number card
2. Identification number

! WARNING

- The smart key should be carried with you. Do not store it on the vehicle.
- When the smart key is within operating range, exercise due care because other people not carrying the smart key can start the engine and operate the vehicle.

Included with the vehicle is one smart key, two mechanical keys, and one identification number card. The identification number can also be found on the inside of the smart key itself. Keep one mechanical key and the identification number card in a safe place separate from the vehicle.

If the vehicle battery is discharged, the mechanical key can be used to open the seat to charge or replace the battery. Therefore it is recommended that you carry one mechanical key together with the smart key.

If the smart key and the smart key system identification number are both lost or damaged, the entire smart key sys-

4

4-3

Smart key system (GDR155-A)

tem will need to be replaced. To prevent this, it is recommended that you write down the identification number in case the identification number card is lost.

EOA21573

NOTICE

The smart key has precision electronic components. Observe the following precautions to prevent possible malfunction or damage.

- Do not place or store the smart key in a storage compartment. The smart key may be damaged from road vibrations or excessive heat.
- Do not drop, bend, or subject the smart key to strong impacts.
- Do not submerge the smart key in water or other liquids.
- Do not place heavy items or excessive stress on the smart key.
- Do not leave the smart key in a place exposed to direct sunlight, high temperature or high humidity.
- Do not grind or attempt to modify the smart key.

- Keep the smart key away from strong magnetic fields and magnetic objects such as key holders, TVs, and computers.
- Keep the smart key away from electric medical equipment.
- Do not allow oils, polishing agents, fuel, or any strong chemicals to come in contact with the smart key. The smart key body may become discolored or cracked.

TIP

- The smart key battery life is approximately two years, but this may vary according to operating conditions.
- Replace the smart key battery when the smart key system indicator light flashes for 20 seconds when the vehicle is turned on, or when the smart key indicator light does not come on when the smart key button is pushed. (See page 4-6.) After changing the smart key battery, if the smart key system

still does not operate, check the vehicle battery and then have a Yamaha dealer check the vehicle.

- If the smart key continually receives radio waves, the smart key battery will discharge quickly. (For example, when placed in the vicinity of electrical products such as televisions, radios, or computers.)
- You can register up to six smart keys for the same vehicle. See a Yamaha dealer regarding spare smart keys.
- If a smart key is lost, contact a Yamaha dealer immediately to prevent the vehicle from being stolen, etc.

4

4-4

Smart key system (GDR155-A)

Smart key

EAU76470

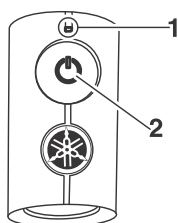

1. Smart key indicator light
2. Smart key button

To turn the smart key on or off

Push and hold the smart key button for approximately 1 second to turn the smart key on or off. When the smart key is turned off, the vehicle cannot be operated even if the smart key is within operating range. To operate the vehicle, turn the smart key on and bring it within operating range. (See **Operating range of the smart key system.**)

To check whether the smart key is turned on or off

Push the smart key button to confirm the current operating status of the smart key.

If the smart key indicator light:

- Short flash (0.1 seconds): The smart key is turned on.
- Long flash (0.5 seconds): The smart key is turned off.

Remote answer-back function

Push the smart key button to operate the answer-back function remotely. The beeper will sound twice and all of the turn signal lights will flash twice. This feature is convenient for locating your vehicle in a parking lot and other areas.

To turn the answer-back beeper on or off

The beeper, which sounds when the answer-back function is operated, can be turned on or off according to the following procedure.

1. Turn the smart key on and bring it within operating range.

2. Turn the main switch to "OFF", and then push the main switch knob once.
3. Within 9 seconds of pushing the knob, push and hold the knob again for 5 seconds.
4. When the beeper sounds, the setting is complete.

If the beeper:

- Sounds twice: The beeper is turned off.
- Sounds once: The beeper is turned on.

4

4-5

Smart key system (GDR155-A)

Replacing the smart key battery

EAU76480

Replace the battery in the following situations.

- The smart key system indicator light flashes for about 20 seconds when the power of the vehicle is turned on.
- The answer-back function does not operate when the smart key button is pushed.



1. Smart key system indicator light “”

WARNING

EWA14724

- The battery and other removable parts may cause injury if swallowed. Keep the battery and other removable parts away from children.
- Do not expose the battery to direct sunlight or other heat sources.

NOTICE

ECA15784

- Use a cloth when opening the smart key case with a screwdriver. Direct contact with hard objects may damage or scratch the smart key.
- Take precautions to prevent the waterproof seal from being damaged or contaminated by dirt.
- Do not touch the internal circuits and terminals. This may cause malfunctions.
- Do not apply excessive force to the smart key when replacing the battery.

- Make sure the battery is installed correctly. Confirm the direction of the positive/“+” side of the battery.

To replace the smart key battery

1. Open the smart key case as shown.

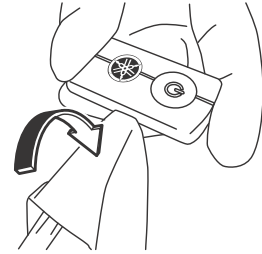

2. Remove the battery.

4

4-6

Smart key system (GDR155-A)

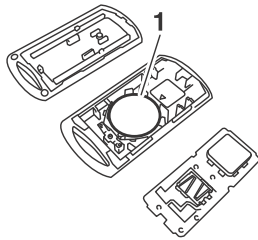

1. Battery

TIP

Dispose of the removed battery in accordance with local regulations.

3. Install a new battery as shown. Note the polarity of the battery.

Specified battery:
CR2032

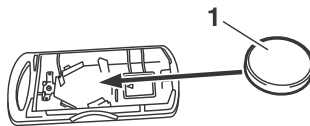

1. Battery

4. Gently snap the smart key case closed.

Main switch

EAU76490

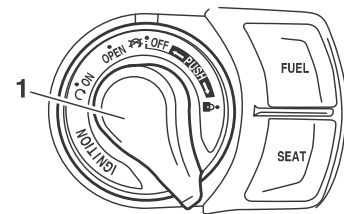

1. Main switch knob

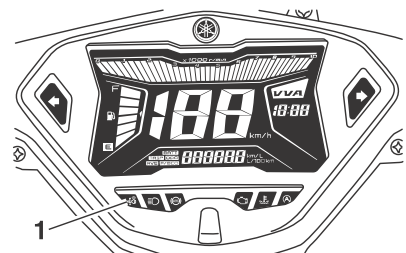

1. Smart key system indicator light “”

The main switch is used to turn the vehicle power on and off, lock and unlock the steering, and open the seat or fuel tank cap lid. After pushing the main switch knob (and confirmation with the

4

4-7

Smart key system (GDR155-A)

smart key has taken place), the main switch can be turned while the smart key system indicator light is on (approximately 4 seconds).

EWA18720

⚠ WARNING

Never turn the main switch to “OFF”, “”, or “OPEN” while the vehicle is moving. Otherwise the electrical systems will be switched off, which may result in loss of control or an accident.

TIP

Do not push the main switch knob repeatedly or turn the main switch back and forth excessively (beyond normal use). To protect the main switch from damage, the smart key system will temporarily disable, and the smart key system indicator light will flash. If this occurs, wait until the indicator light stops flashing, and then operate the main switch.

The main switch positions are described below.

ON (on)

EAU76500

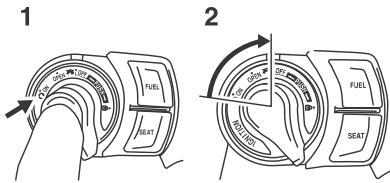

1. Push.
2. Turn.

All electrical circuits are supplied with the power, and the engine can be started.

To turn the vehicle power on

1. Turn the smart key on and bring it within operating range.
2. Push the main switch knob and the smart key indicator light will come on for approximately 4 seconds.

3. While the smart key system indicator light is on, turn the main switch to “ON”. All of the turn signal lights flash twice and the vehicle power turns on.

TIP

- If the vehicle battery voltage is low, the turn signal lights will not flash.
- See “Emergency mode” on page 9-38 for information on turning the vehicle power on without the smart key.

4

OFF (off)

EAU76510

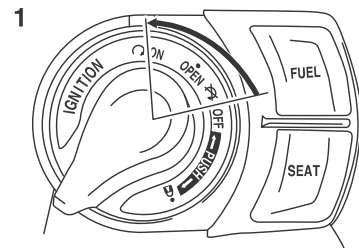

1. Turn.

All electrical systems are off.

4-8

Smart key system (GDR155-A)

To turn the vehicle power off

1. With the smart key turned on and within operating range, turn the main switch to “OFF”.
2. The turn signal lights flash once and the vehicle power turns off.

TIP

When the main switch is turned to “OFF” but the smart key cannot be confirmed (the smart key is either outside operation range or has been turned off), the beeper will sound for 3 seconds and the smart key system indicator light will flash for 30 seconds.

- During this 30 seconds, the main switch can be freely operated.
- After 30 seconds, the vehicle power will turn off automatically.
- To turn the vehicle power off immediately, push the main switch knob four times within 2 seconds.

(lock)

EAU76520

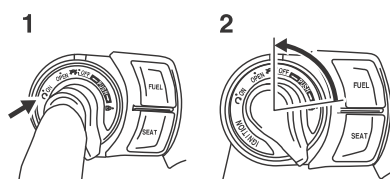

1. Push.
2. Turn.

The steering is locked and all electrical systems are off.

To lock the steering

1. Turn the handlebar all the way to the left.
2. With the smart key turned on and within operating range, turn and push the main switch to “”.

TIP

If the steering will not lock, try turning the handlebar back to the right slightly.

To unlock the steering

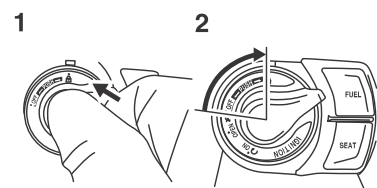

1. Push.
2. Turn.

1. With the smart key turned on and within operating range, push the main switch knob.
2. While the smart key system indicator light is on, push and turn the main switch to the desired position.

4

4-9

Smart key system (GDR155-A)

EAU76530

Fuel tank cap lid opening and closing

To open the fuel tank cap lid

1. With the smart key on and within operating range, push the main switch knob.

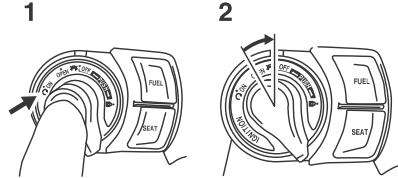

1. Push.
2. Turn.

2. While the smart key system indicator light is on, turn the main switch to "OPEN".
3. Push the "FUEL" button to open the fuel tank cap lid.

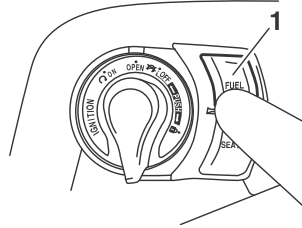

1. "FUEL" button

TIP

When the main switch is in the "OPEN" position and the smart key is moved out of operating range, the beeper will sound. The beeper will also sound if the main switch is left in the "OPEN" position for 3 minutes. To stop the beeper, move the smart key back to within operating range or turn the main switch to "OFF".

To close the fuel tank cap lid

Push the fuel tank cap lid until it is closed.

TIP

Make sure that the lid is securely closed before riding.

4

4-10

Smart key system (GDR155-A)

EAU76541

Seat opening and closing

To open the seat

To open the seat via the main switch

1. With the smart key on and within operating range, push the main switch knob.

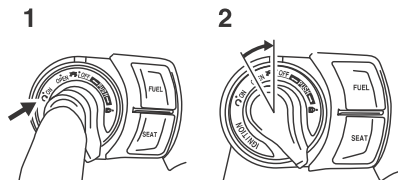

1. Push.
2. Turn.

2. While the smart key system indicator light is on, turn the main switch to "OPEN".

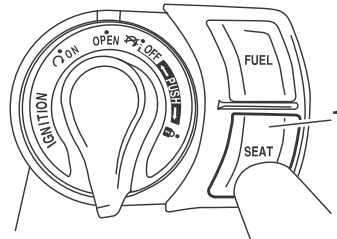

1. "SEAT" button

3. Push the "SEAT" button, and then lift the rear of the seat.

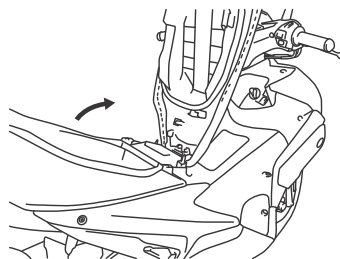

TIP

When the main switch is in the "OPEN" position and the smart key is moved out of operating range, the beeper will sound. The beeper will also sound if the main switch is left in the "OPEN"

position for 3 minutes. To stop the beeper, move the smart key back to within operating range or turn the main switch to "OFF".

To open the seat with the mechanical key

1. Open the keyhole cover.
2. Insert the mechanical key into the seat lock, and then turn it clockwise.

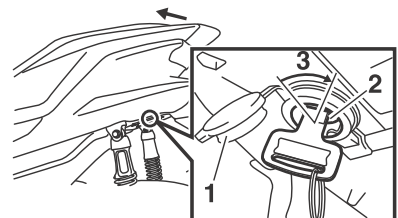

1. Keyhole cover
2. Seat lock
3. Unlock.

3. Lift the rear of the seat.

4

4-11

Smart key system (GDR155-A)

ECA24020

NOTICE

Make sure that the keyhole cover is installed when the mechanical key is not being used.

To close the seat

Close the seat and push down on the rear to lock it in position.

TIP

Make sure that the seat is properly secured before riding.

Stop and Start System (GDR155-A)

Stop and Start System

EAU76823

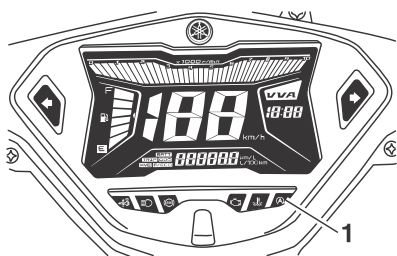

1. Stop and Start System indicator light “A”

The Stop and Start System is a system that stops the engine automatically when the vehicle is stopped while the Stop and Start System indicator light is on to prevent noise, control exhaust emissions, and reduce fuel consumption.

When the rider turns the throttle grip slightly, the engine restarts automatically and the vehicle starts off.

ECA23961

NOTICE

When parking the vehicle or leaving the vehicle unattended, be sure to turn the main switch off. If the Stop and Start System is left turned on,

the battery could become discharged and it may not be possible to restart the engine due to insufficient battery voltage.

TIP

- Although the engine normally stops at the same time the vehicle is stopped, it may take a while until the engine stops when operating the vehicle under 10km/h such as in heavy traffic.
- If you think the battery voltage has decreased because the engine cannot be started using the starter switch or for some other reason, do not turn on the Stop and Start System.
- Have a Yamaha dealer check the battery at the intervals specified in the periodic maintenance chart.

Stop and Start System operation

EAU76671

Activating the Stop and Start System

EAU76683

1. Turn the main switch on.

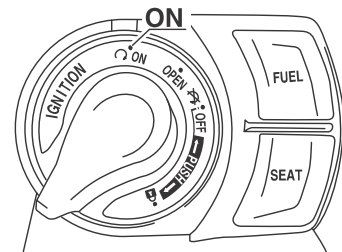

2. Set the Stop and Start System switch to “A”.

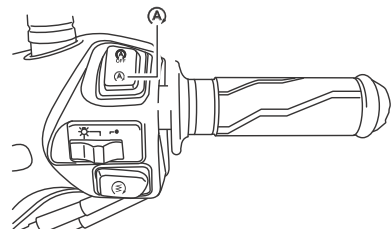

Stop and Start System (GDR155-A)

3. When the vehicle confirms that the following conditions are met, the Stop and Start System activates and the Stop and Start System indicator light comes on.

- The Stop and Start System switch is set to “A”.
- After the engine was warmed up, the engine was left idling for a certain period of time.
- The vehicle has traveled at a speed of 10 km/h or higher.



4. To turn off the Stop and Start System, set the Stop and Start System switch to “OFF”.

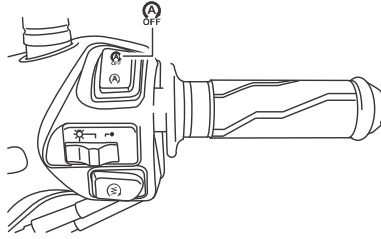

TIP
To preserve battery power, the Stop and Start System may not activate.

Stop the engine

After the “A” indicator light on the multi-function meter comes on, the engine stops automatically when the engine is left idling when the vehicle is stopped and the throttle grip is in the fully closed position.

At this time, the “A” indicator light on the multi-function meter starts flashing to indicate that the engine is currently stopped by the Stop and Start System.

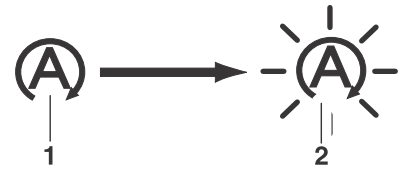

1. On
2. Flashing

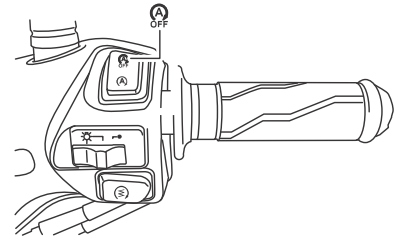

Restart the engine

If you turn the throttle grip while the Stop and Start System indicator light is flashing and the engine is stopped, the engine restarts automatically and the “A” indicator light stops flashing.

5-2

5

Stop and Start System (GDR155-A)

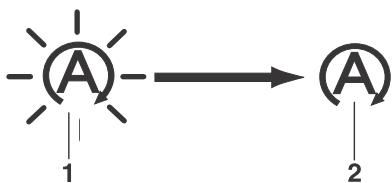

1. Flashing
2. Off

WARNING

Do not turn the throttle grip quickly when the Stop and Start System is activated and the engine is stopped. Otherwise, the vehicle could start moving unexpectedly after the engine restarts.



- TIP**
- When the sidestand is lowered, the Stop and Start System is deactivated.
 - If the Stop and Start System does not operate correctly, have a Yamaha dealer check the vehicle.

Precautions when using the Stop and Start System

In order to prevent accidents due to improper operation, carefully read and observe the following precautions.

WARNING

When walking while pushing the vehicle, be sure to turn the main switch off. If the vehicle is pushed while the

Stop and Start System is left turned on, the engine could start and the vehicle could start moving if the throttle grip is turned accidentally.

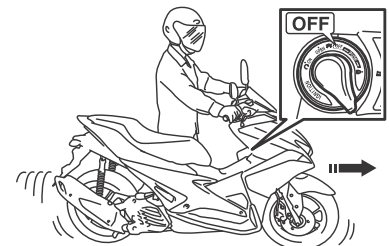

WARNING

When placing the vehicle on the centerstand, be sure to turn the main switch off. If the vehicle is placed on the centerstand while the Stop and Start System is left turned on, the engine could start and the vehicle could start moving if the throttle grip is turned accidentally.

5-3

Stop and Start System (GDR155-A)

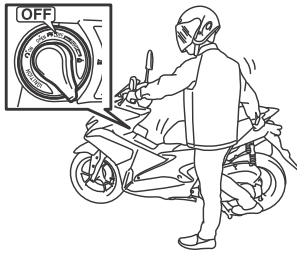

EWA18771

WARNING

- When leaving the vehicle unattended, be sure to turn the main switch off.
- Do not leave the Stop and Start System turned on when parking the vehicle. Otherwise, the engine could start and the vehicle could start moving if the throttle grip is turned accidentally.

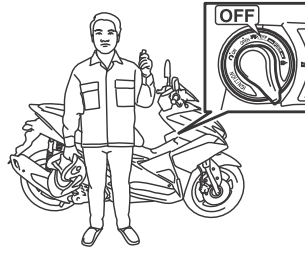

EWA18781

WARNING

Before performing maintenance, be sure to turn the main switch off. If maintenance is performed while the Stop and Start System is turned on, the engine could start and the vehicle could start moving if the throttle grip is turned.

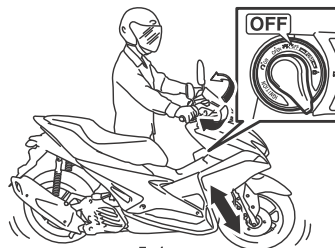

5-4

Instrument and control functions

Indicator lights and warning lights

EAU77122

GDR155-A

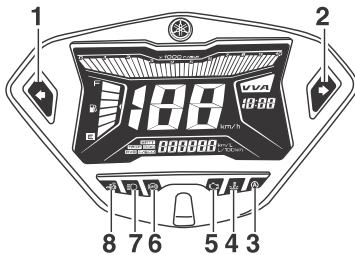

1. Left turn signal indicator light “↶”
2. Right turn signal indicator light “↷”
3. Stop and Start System indicator light “(A)”
4. Coolant temperature warning light “⊡”
5. Engine trouble warning light “(E)”
6. Anti-lock Brake System (ABS) warning light “(ABS)”
7. High beam indicator light “≡O”
8. Smart key system indicator light “(K)”

Turn signal indicator lights “↶” and “↷”

EAU11032

Each indicator light will flash when its corresponding turn signal lights are flashing.

High beam indicator light “≡O”

EAU11081

This indicator light comes on when the high beam of the headlight is switched on.

Coolant temperature warning light “⊡”

EAU67441

This warning light comes on if the engine overheats. If this occurs, stop the engine immediately and allow the engine to cool.

The electrical circuit of the warning light can be checked by turning the main switch on. The warning light should come on for a few seconds, and then go off.

If the warning light does not come on initially when main switch is turned on, or if the warning light remains on, have a Yamaha dealer check the electrical circuit.

ECA10022

NOTICE

Do not continue to operate the engine if it is overheating.

TIP

If the engine overheats, see page 9-37 for further instructions.

Instrument and control functions

Engine trouble warning light “” EAU42776

This warning light comes on if a problem is detected in the electrical circuit monitoring the engine. If this occurs, have a Yamaha dealer check the self-diagnosis system. (See page 6-9 for an explanation of the self-diagnosis device.)

The electrical circuit of the warning light can be checked by turning the main switch on. The warning light should come on for a few seconds, and then go off.

If the warning light does not come on initially when the main switch is turned on, or if the warning light remains on, have a Yamaha dealer check the electrical circuit.

ABS warning light “” (for ABS models) EAU1961

In normal operation, the ABS warning light comes on when the main switch is turned on, and goes off after traveling at a speed of 10 km/h (6 mi/h) or higher.

If the ABS warning light:

- does not come on when the main switch is turned on
- comes on or flashes while riding
- does not go off after traveling at a speed of 10 km/h (6 mi/h) or higher

The ABS may not work correctly. If any of the above occurs, have a Yamaha dealer check the system as soon as possible. (See page 6-11 for an explanation of the ABS.)

WARNING

If the ABS warning light does not go off after traveling at a speed of 10 km/h (6 mi/h) or higher, or if the warning light comes on or flashes while riding, the brake system reverts to conventional braking. If either of the above occurs, or if the warning light does not come on at all, use extra caution to avoid possible wheel lock during emergency braking. Have a Yamaha dealer check the brake system and electrical circuits as soon as possible.

TIP

The ABS warning light may come on while accelerating the engine with the vehicle on its centerstand, but this does not indicate a malfunction.

Smart key system indicator light “” (GDR155-A) EAU61654

This indicator light communicates the status of the smart key system. When the smart key system is operating normally, this indicator light will be off. If there is an error in the smart key system, the indicator light will flash. The indicator light will also flash when communication between the vehicle and smart key takes place and when certain smart key system operations are carried out.

6

6-2

Instrument and control functions

TIP

When the start switch is pushed, the indicator light will come on for about one second and then go off. If the indicator light does not come on or go off as normal, have a Yamaha dealer check the vehicle.

Stop and Start System indicator light “” (GDR155-A) EAU76382

This indicator light comes on when the Stop and Start System activates. The indicator light will flash when the engine is automatically stopped by the Stop and Start System.

TIP

Even if the Stop and Start Switch is set to “”, this indicator light may not come on. (See page 5-1.)

Multi-function meter unit EAU77153

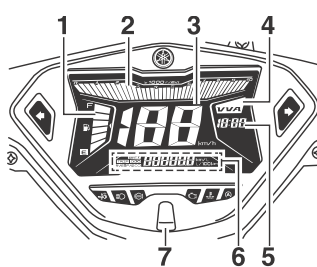

1. Fuel meter
2. Tachometer
3. Speedometer
4. VVA (variable valve actuation) indicator
5. Clock
6. Multi-function display
7. “RESET/SELECT” button

WARNING

Be sure to stop the vehicle before making any setting changes to the multi-function meter unit. Changing settings while riding can distract the operator and increase the risk of an accident.

The multi-function meter unit is equipped with the following:

- a speedometer
- a tachometer
- a VVA indicator
- a clock
- a fuel meter
- a multi-function display

TIP

Be sure to turn the main switch on before using the “RESET/SELECT” button.

Speedometer



1. Speedometer

The speedometer shows the vehicle's traveling speed.

6

6-3

Instrument and control functions

Tachometer

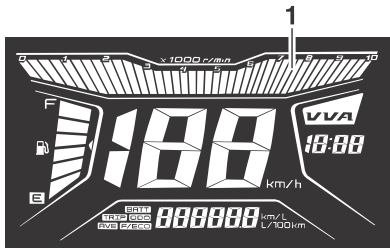

1. Tachometer

The electric tachometer allows the rider to monitor the engine speed and keep it within the ideal power range.

VVA indicator

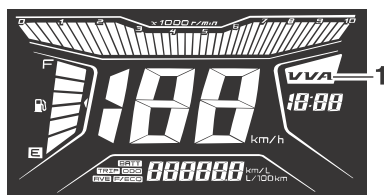

1. VVA (variable valve actuation) indicator

This model is equipped with variable valve actuation (VVA) for good fuel economy and acceleration in both the low-speed and high-speed ranges. The VVA indicator comes on when the variable valve actuation system has switched to the high-speed range. The VVA indicator can be turned off (or on) as follows:

1. Turn the main switch to "OFF".
2. Hold the "RESET/SELECT" button pushed and turn the main switch to "ON".
3. Release the "RESET/SELECT" after one second.
4. Push the "RESET/SELECT" button to turn the indicator off (or on).

TIP

Turning the VVA indicator off does not turn off the variable valve actuation system.

Clock

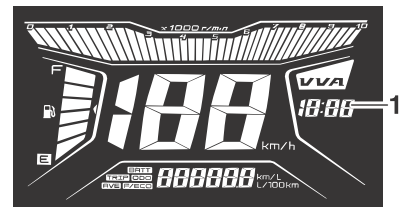

1. Clock

The clock uses a 12-hour time system.

To set the clock

1. With the display in the odometer mode, push the "RESET/SELECT" button for four seconds.
2. When the hour digits start flashing, use the "RESET/SELECT" button to set the hours.
3. Push the "RESET/SELECT" button for two seconds, and the minutes will start flashing.
4. Use the "RESET/SELECT" button to set the minutes.
5. Push the "RESET/SELECT" button for two seconds to start the clock.

Instrument and control functions

TIP

If you do not push the "RESET/SELECT" button for 90 seconds, the clock will not be set and will return to the prior time.

Fuel meter



1. Fuel meter

The fuel meter indicates the amount of fuel in the fuel tank. The display segments of the fuel meter disappear from "F" (full) towards "E" (empty) as the fuel level decreases. When the last segment start flashing, refuel as soon as possible.

When the main switch is turned on, all of the display segments of the fuel meter will appear for a few seconds, and then the fuel meter shows the actual fuel level.

TIP

- Do not use up all of the fuel in the fuel tank.
- The fuel meter is equipped with a self-diagnosis function. If a problem is detected in the fuel meter electrical circuit, all the display segments will flash repeatedly. If this occurs, have a Yamaha dealer check the vehicle.

ECAV0041

NOTICE

When the fuel indicator has dropped to only one block, refuel as soon as possible, as the movement of fuel when going up or downhill or when turning may lead to the engine not getting any fuel, resulting in engine stop.

Multi-function display

The multi-function display is equipped with the following:

- an odometer
- a tripmeter
- an instantaneous fuel consumption display
- an average fuel consumption display
- a battery voltage indicator
- an error code display

Push the "RESET/SELECT" button to switch the display between the odometer "ODO", the tripmeter "TRIP", the instantaneous fuel consumption "F/ECO" (km/L or L/100 km), the average fuel consumption "AVE F/ECO" (km/L or L/100 km) and the battery voltage "BATT" in the following order:

ODO → TRIP → F/ECO → AVE F/ECO → BATT → ODO

Instrument and control functions

Odometer mode

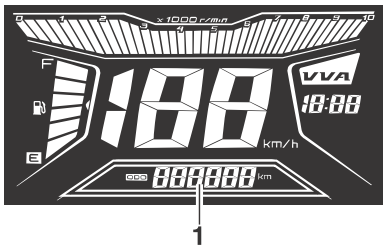

1. Odometer

The odometer shows the total distance traveled by the vehicle.

Tripmeter mode

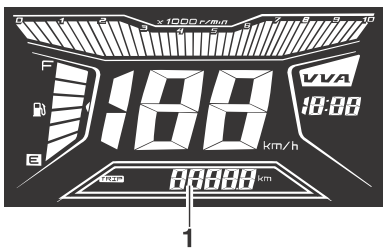

1. Tripmeter

The tripmeter shows the total distance traveled since it was last reset.

TIP

- The odometer will lock at 999999 and cannot be reset.
- The tripmeter will reset and continue counting after 9999.9 is reached. To reset the tripmeter, while it is being displayed, press the “RESET/SELECT” button for at least one second.

Instantaneous fuel consumption mode

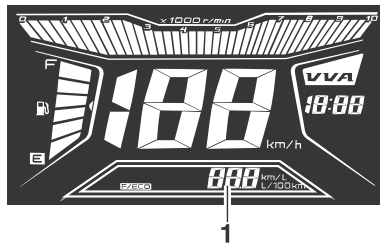

1. Instantaneous fuel consumption display

The instantaneous fuel consumption display can be set to either “km/L” or “L/100 km”.

- “km/L”: The distance that can be traveled on 1.0 L of fuel under the current riding conditions is shown.
- “L/100 km”: The amount of fuel necessary to travel 100 km under the current riding conditions is shown.

To switch between the instantaneous fuel consumption display settings, push the “RESET/SELECT” button for one second.

TIP

If traveling at speeds under 10 km/h, “_ _ _” is displayed.

Average fuel consumption mode

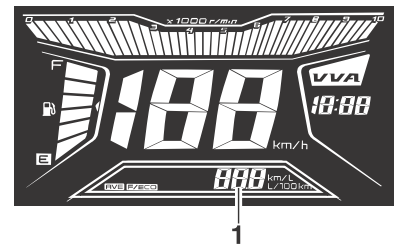

1. Average fuel consumption display

Instrument and control functions

This display shows the average fuel consumption since it was last reset. The average fuel consumption display can be set to either “km/L” or “L/100 km”.

- “km/L”: The average distance that can be traveled on 1.0 L of fuel is shown.
- “L/100 km”: The average amount of fuel necessary to travel 100 km is shown.

To switch between the average fuel consumption display settings, push the “RESET/SELECT” button for one second.

To reset the average fuel consumption, push the “RESET/SELECT” button for at least one second.

TIP

After resetting the average fuel consumption, “_ _ _” will be shown until the vehicle has traveled 0.1 km (0.06 mi).

The battery voltage indicator

This indicator shows the current charge state of the battery.

- Over 12.8 V Full charge

- Under 12.7 V Charging is required.

TIP

If the battery voltage is less than 9.0 V, “_ _ _” will be displayed.

Self-diagnosis mode

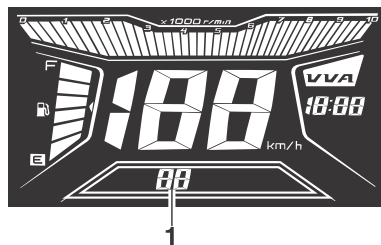

1. Error code display

This model is equipped with a self-diagnosis device for various electrical circuits.

If a problem is detected in any of those circuits, the engine trouble warning light will come on and the display will indicate an error code.

If the display indicates any error codes, note the code number and have a Yamaha dealer check the vehicle.

NOTICE

If the display indicates an error code, the vehicle should be checked as soon as possible in order to avoid engine damage.

ECA11591

Instrument and control functions

Handlebar switches

EAU1234M

Left

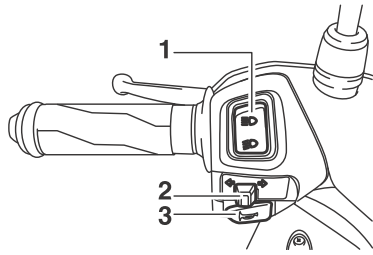

1. Dimmer switch “/”
2. Turn signal switch “/”
3. Horn switch “”

Right (GDR155-A)

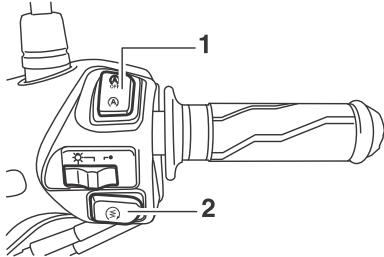

1. Stop and Start System switch “”
2. Start switch “”

Dimmer switch “/”

EAU12401

Set this switch to “” for the high beam and to “” for the low beam.

Turn signal switch “/”

EAU12461

To signal a right-hand turn, push this switch to “”. To signal a left-hand turn, push this switch to “”. When released, the switch returns to the center position. To cancel the turn signal lights, push the switch in after it has returned to the center position.

Horn switch “”

EAU12501

Press this switch to sound the horn.

Start switch “”

EAU12722

With the sidestand up, push this switch while applying the front or rear brake to crank the engine with the starter. See page 8-1 for starting instructions prior to starting the engine.

Stop and Start System switch “” (GDR155-A)

EAU76391

To turn on the Stop and Start System, set the switch to “”. To turn off the Stop and Start System, set this switch to “”.

6

6-8

Instrument and control functions

Front brake lever

EAU12892

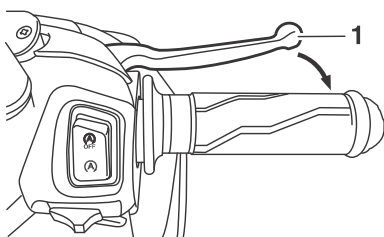

1. Front brake lever

The front brake lever is located on the right side of the handlebar. To apply the front brake, pull this lever toward the throttle grip.

Rear brake lever

EAU12952

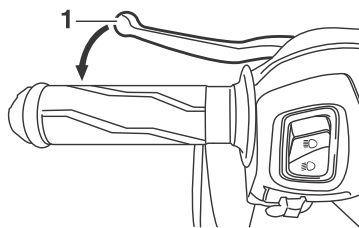

1. Rear brake lever

The rear brake lever is located on the left side of the handlebar. To apply the rear brake, pull this lever toward the handlebar grip.

ABS (for ABS models)

EAU77820

This model's ABS (anti-lock brake system) acts on the front brake system. Operate the brakes as you normally would with a conventional brake system. If the ABS is activated, a pulsating sensation may be felt at the front brake lever. In this situation, continue to apply the brakes and let the ABS work; do not release and re-apply the brakes (i.e., pump the brakes) as this will reduce braking effectiveness.

WARNING

EAU16051

Always keep a sufficient distance from the vehicle ahead to match the riding speed even with ABS.

- The ABS performs best with long braking distances.
- On certain surfaces, such as rough or gravel roads, the braking distance may be longer with the ABS than without.

The ABS is monitored by an ECU, which will revert the system to conventional braking if a malfunction occurs.

6

6-9

Instrument and control functions

TIP

The ABS performs a self-diagnosis test each time the vehicle first starts off after the key is turned to "ON" and the vehicle has traveled at a speed of 10 km/h (6 mi/h) or higher. During this test, a clicking noise may be audible, and a vibration may be felt at the brake lever, but these do not indicate a malfunction.

ECA20100

NOTICE

Be careful not to damage the wheel sensor or wheel sensor rotor; otherwise, improper performance of the ABS will result.

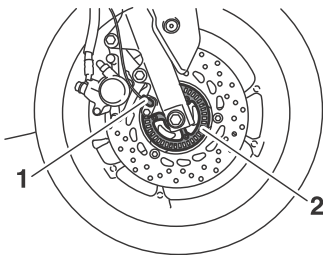

1. Front wheel sensor
2. Front wheel sensor rotor

Fuel tank cap

EAUJ0681

To remove the fuel tank cap

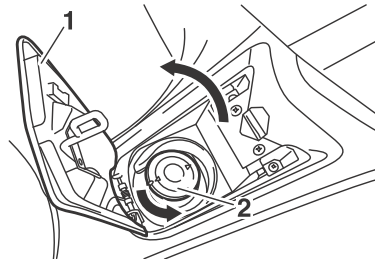
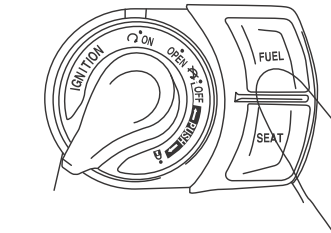

1. Fuel tank cap lid
2. Fuel tank cap

1. Turn the main switch to "OPEN" position.
2. Push the "FUEL" button to open the fuel tank cap lid.

6-10

3. Turn the fuel tank cap counter-clockwise and pull it off.

To install the fuel tank cap

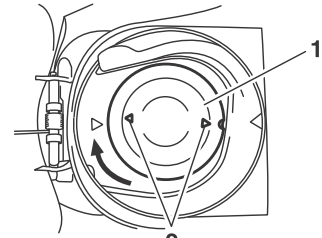

1. Fuel tank cap
2. "Δ" mark

1. Insert the fuel tank cap into the tank opening and turn it clockwise until the "Δ" marks on the cap and tank are aligned.
2. Push the fuel tank cap lid down into its original position. A clicking sound can be heard when the fuel tank cap lid is locked.

EWA11092

WARNING

Make sure that the fuel tank cap is properly closed after filling fuel. Leaking fuel is a fire hazard.

6

Instrument and control functions

Fuel

EAU13213

Make sure there is sufficient gasoline in the tank.

EWA10882

WARNING

Gasoline and gasoline vapors are extremely flammable. To avoid fires and explosions and to reduce the risk of injury when refueling, follow these instructions.

1. Before refueling, turn off the engine and be sure that no one is sitting on the vehicle. Never refuel while smoking, or while in the vicinity of sparks, open flames, or other sources of ignition such as the pilot lights of water heaters and clothes dryers.
2. Do not overfill the fuel tank. Stop filling when the fuel reaches the bottom of the filler tube. Because fuel expands when it heats up, heat from the engine or the sun can cause fuel to spill out of the fuel tank.

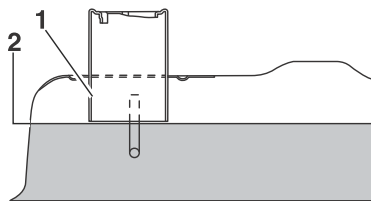

1. Fuel tank filler tube
2. Maximum fuel level

3. Wipe up any spilled fuel immediately. **NOTICE: Immediately wipe off spilled fuel with a clean, dry, soft cloth, since fuel may deteriorate painted surfaces or plastic parts.** [ECA10072]
4. Be sure to securely close the fuel tank cap.

EWA15152

WARNING

Gasoline is poisonous and can cause injury or death. Handle gasoline with care. Never siphon gasoline by mouth. If you should swallow some gasoline or inhale a lot of gas-

oline vapor, or get some gasoline in your eyes, see your doctor immediately. If gasoline spills on your skin, wash with soap and water. If gasoline spills on your clothing, change your clothes.

EAUN0750

Recommended fuel:

Regular unleaded gasoline only

Fuel tank capacity:

4.6 L (1.2 US gal, 1.0 Imp.gal)

ECA11401

NOTICE

Use only unleaded gasoline. The use of leaded gasoline will cause severe damage to internal engine parts, such as the valves and piston rings, as well as to the exhaust system.

6

Instrument and control functions

Fuel tank overflow hose

EAU58301

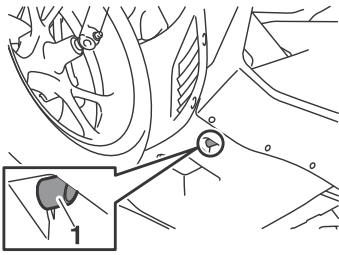

1. Fuel tank overflow hose

Before operating the vehicle:

- Check the fuel tank overflow hose connection and routing.
- Check the fuel tank overflow hose for cracks or damage, and replace it if necessary.
- Make sure that the fuel tank overflow hose is not blocked, and clean it if necessary.

Catalytic converter

EAU13434

This model is equipped with a catalytic converter in the exhaust system.

EWA10863

WARNING

The exhaust system is hot after operation. To prevent a fire hazard or burns:

- Do not park the vehicle near possible fire hazards such as grass or other materials that easily burn.
- Park the vehicle in a place where pedestrians or children are not likely to touch the hot exhaust system.
- Make sure that the exhaust system has cooled down before doing any maintenance work.
- Do not allow the engine to idle more than a few minutes. Long idling can cause a build-up of heat.

NOTICE

Use only unleaded gasoline. The use of leaded gasoline will cause unreparable damage to the catalytic converter.

6

6-12

Instrument and control functions

Seat

EAU62381

To open the seat

1. Insert the key into main switch and then turn it to "OPEN" position.

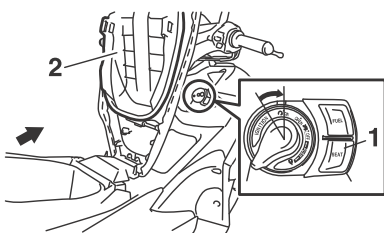

1. Seat lock
2. Seat

2. Push the "SEAT" button to open the seat.

To close the seat

Push the rear of the seat down to lock it in place.

TIP

Make sure that the seat is properly secured before riding.

Helmet holders

EAU37482

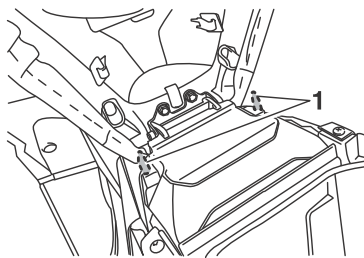

1. Helmet holder

The helmet holders are located under the seat.

To secure a helmet to a helmet holder

1. Open the seat.
2. Attach a helmet to a helmet holder, and then securely close the seat. **WARNING! Never ride with a helmet attached to the helmet holder, since the helmet may hit objects, causing loss of control and possibly an accident.** [EWA10162]

To release a helmet from a helmet holder

Open the seat, remove the helmet from the helmet holder, and then close the seat.

6

6-13

Instrument and control functions

Storage compartments

EAUJ0691

Front storage compartment

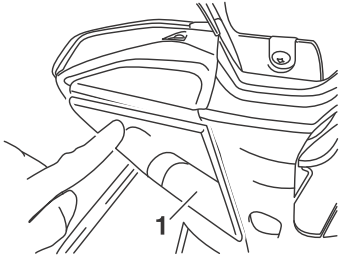

1. Front storage cover

To open the storage compartment, push the front storage compartment cover as shown.

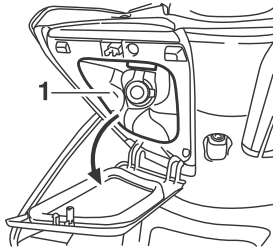

1. Front storage compartment

Rear storage compartment

A helmet can be stored in the rear storage compartment under the seat. (See page 4-11 for seat opening and closing information.) To store a helmet in the rear storage compartment, place the helmet upside down with the front facing to the left side.

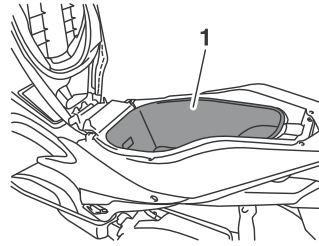

1. Rear storage compartment

TIP

- Some helmets cannot be stored in the rear storage compartment because of their size or shape.
- Do not leave your scooter unattended with the seat open.
- The interior of the rear storage compartment lies outside the operating range of the smart key. If

6-14

the rear storage compartment is locked with the smart key inside, the smart key system may be disabled. The smart key must be carried by the rider.

- Do not place the smart key, mechanical key, or identification number tag inside the rear storage compartment. They may get locked inside and the smart key system may not operate normally.

ECA15983

NOTICE

- Do not leave the seat open for an extended period of time, otherwise the light may cause the battery to discharge.
- Since the storage compartment may get wet while the scooter is being washed, wrap any articles stored in the compartment in a plastic bag.
- To avoid humidity from spreading through the storage compartment and to discourage possible mold growth, wrap wet

6

Instrument and control functions

articles in a plastic bag before storing them in the compartment.

- Do not keep anything valuable or breakable in the storage compartment.
- Since the storage compartment accumulates heat from the engine and from direct sunlight, do not store anything susceptible to heat, such as food or flammable items, inside the compartment.

EWA15861

WARNING

Do not exceed the following loading limits:

- Front storage compartment: 0.2 kg (0.4 lb)
- Rear storage compartment: 3 kg (6.6 lb)
- Maximum load for the vehicle: 153 kg (337 lb) (GDR155-A)

Sidestand

EAU76780

The sidestand is located on the left side of the frame. Raise the sidestand or lower it with your foot while holding the vehicle upright.

TIP

- The built-in sidestand switch is part of the ignition circuit cut-off system, which cuts the ignition in certain situations. (See the following section for an explanation of the ignition circuit cut-off system.)
- When the sidestand is lowered, the Stop and Start System is deactivated.

EWA10242

WARNING

The vehicle must not be ridden with the sidestand down, or if the sidestand cannot be properly moved up (or does not stay up), otherwise the sidestand could contact the ground and distract the operator, resulting in a possible loss of control. Yamaha's ignition circuit cut-off system has been designed to assist the operator in fulfilling the respon-

sibility of raising the sidestand before starting off. Therefore, check this system regularly and have a Yamaha dealer repair it if it does not function properly.

EAUT1097

Ignition circuit cut-off system

Check the operation of the sidestand switch according to the following procedure.

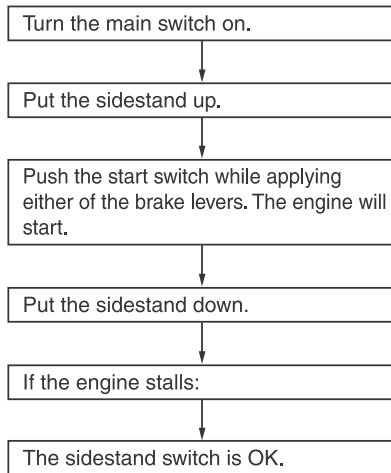

⚠ WARNING

- The vehicle must be placed on the center-stand during this inspection.
- If a malfunction is noted, have a Yamaha dealer check the system before riding.

Instrument and control functions

Auxiliary DC jack

EAUM2852

EWA14361

⚠ WARNING

To prevent electrical shock or short-circuiting, make sure that the cap is installed when the auxiliary DC jack is not being used.

ECA15432

NOTICE

The accessory connected to the auxiliary DC jack should not be used with the engine turned off, and the load must never exceed 12 W (1A), otherwise the fuse may blow or the battery may discharge.

This vehicle is equipped with an auxiliary DC jack in the front storage compartment.

A 12-V accessory connected to the auxiliary jack can be used when the main switch is on and should only be used when the engine is running.

To use the auxiliary DC jack

1. Open the front storage compartment lid. (See page 6-16.)
2. Turn the main switch off.

3. Remove the auxiliary DC jack cap.

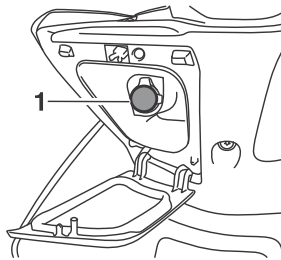

1. Auxiliary DC jack cap

4. Turn the accessory off.
5. Insert the accessory plug into the auxiliary DC jack.

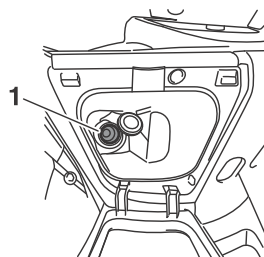

1. Auxiliary DC jack

6. Turn the main switch on, and then start the engine. (See page 8-1.)
7. Turn the accessory on.

For your safety – pre-operation checks

EAU15599

Inspect your vehicle each time you use it to make sure the vehicle is in safe operating condition. Always follow the inspection and maintenance procedures and schedules described in the Owner's Manual.

EWA11152

WARNING

Failure to inspect or maintain the vehicle properly increases the possibility of an accident or equipment damage. Do not operate the vehicle if you find any problem. If a problem cannot be corrected by the procedures provided in this manual, have the vehicle inspected by a Yamaha dealer.

Before using this vehicle, check the following points:

ITEM	CHECKS	PAGE
Fuel	<ul style="list-style-type: none"> • Check fuel level in fuel tank. • Refuel if necessary. • Check fuel line for leakage. • Check fuel tank overflow hose for obstructions, cracks or damage, and check hose connection. 	6-11, 6-12
Engine oil	<ul style="list-style-type: none"> • Check oil level in engine. • If necessary, add recommended oil to specified level. • Check vehicle for oil leakage. 	9-10
Final transmission oil	<ul style="list-style-type: none"> • Check vehicle for oil leakage. 	9-12
Coolant	<ul style="list-style-type: none"> • Check coolant level in reservoir. • If necessary, add recommended coolant to specified level. • Check cooling system for leakage. 	9-13
Front brake	<ul style="list-style-type: none"> • Check operation. • If soft or spongy, have Yamaha dealer bleed hydraulic system. • Check brake pads for wear. • Replace if necessary. • Check fluid level in reservoir. • If necessary, add specified brake fluid to specified level. • Check hydraulic system for leakage. 	9-21, 9-22

7-1

7

For your safety – pre-operation checks

ITEM	CHECKS	PAGE
Rear brake	<ul style="list-style-type: none"> • Check operation. • Lubricate cable if necessary. • Check lever free play. • Adjust if necessary. 	9-20, 9-21
Throttle grip	<ul style="list-style-type: none"> • Make sure that operation is smooth. • Check throttle grip free play. • If necessary, have Yamaha dealer adjust throttle grip free play and lubricate cable and grip housing. 	9-17, 9-24
Control cables	<ul style="list-style-type: none"> • Make sure that operation is smooth. • Lubricate if necessary. 	9-23
Wheels and tires	<ul style="list-style-type: none"> • Check for damage. • Check tire condition and tread depth. • Check air pressure. • Correct if necessary. 	9-18, 9-19
Brake levers	<ul style="list-style-type: none"> • Make sure that operation is smooth. • Lubricate lever pivoting points if necessary. 	9-24
Centerstand, sidestand	<ul style="list-style-type: none"> • Make sure that operation is smooth. • Lubricate pivots if necessary. 	9-25
Chassis fasteners	<ul style="list-style-type: none"> • Make sure that all nuts, bolts and screws are properly tightened. • Tighten if necessary. 	—
Instruments, lights, signals and switches	<ul style="list-style-type: none"> • Check operation. • Correct if necessary. 	—
Sidestand switch	<ul style="list-style-type: none"> • Check operation of ignition circuit cut-off system. • If system is not working correctly, have Yamaha dealer check vehicle. 	6-17

7

7-2

Operation and important riding points

EAU15952

Read the Owner's Manual carefully to become familiar with all controls. If there is a control or function you do not understand, ask your Yamaha dealer.

EWA10272

WARNING

Failure to familiarize yourself with the controls can lead to loss of control, which could cause an accident or injury.

EAUN0073

ECAN0072

NOTICE

Do not ride through deep water, otherwise the engine may be damaged. Avoid puddles because they may be deeper than expected.

EAU77800

ECA10251

Starting the engine

NOTICE

See page 8-4 for engine break-in instructions prior to operating the vehicle for the first time.

In order for the ignition circuit cut-off system to enable starting, the side-stand must be up. (See page 6-18.)

1. Turn the main switch on.

The following warning lights and indicator lights should come on for a few seconds, then go off.

- Engine trouble warning light
- Coolant temperature warning light
- Turn signal indicator lights
- Stop and Start System indicator light (GDR155-A)
- Smart key system indicator light (GDR155-A)
- ABS warning light (GDR155-A)

8

8-1

Operation and important riding points

TIP

The ABS warning light should come on and stay on until the vehicle reaches a traveling speed of 10 km/h (6 mi/h) or higher.

ECA22510

NOTICE

If a warning or indicator light does not work as described above, see page 6-3 for the corresponding warning and indicator light circuit check.

2. Close the throttle.
3. While applying the front or rear brake, push the start switch. Release it when the engine starts.

TIP

If the engine does not start, release the start switch after 5 seconds. Before pressing the start switch again, wait 10 seconds to allow battery voltage to restore.

ECA11043

NOTICE

For maximum engine life, never accelerate hard when the engine is cold!

EAU45093

Starting off

1. While pulling the rear brake lever with your left hand and holding the grab bar with your right hand, push the scooter off the center-stand.

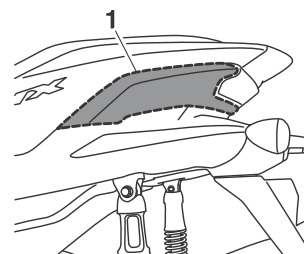

1. Grab bar

2. Sit astride the seat, and then adjust the rear view mirrors.
3. Switch the turn signals on.
4. Check for oncoming traffic, and then slowly turn the throttle grip (on the right) in order to take off.
5. Switch the turn signals off.

8

8-2

Acceleration and deceleration EAU16782

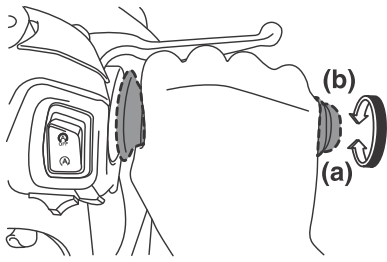

The speed can be adjusted by opening and closing the throttle. To increase the speed, turn the throttle grip in direction (a). To reduce the speed, turn the throttle grip in direction (b).

Braking

⚠ WARNING

- **Avoid braking hard or suddenly (especially when leaning over to one side), otherwise the scooter may skid or overturn.**
- **Railroad crossings, streetcar rails, iron plates on road construction sites, and manhole covers become extremely slippery when wet. Therefore, slow down when approaching such areas and cross them with caution.**
- **Keep in mind that braking on a wet road is much more difficult.**
- **Ride slowly down a hill, as braking downhill can be very difficult.**

1. Close the throttle completely.
2. Apply both front and rear brakes simultaneously while gradually increasing the pressure.

Tips for reducing fuel consumption EAU16794

Fuel consumption depends largely on your riding style. Consider the following tips to reduce fuel consumption:

- Avoid high engine speeds during acceleration.
- Avoid high engine speeds with no load on the engine.
- Turn the engine off instead of letting it idle for an extended length of time (e.g., in traffic jams, at traffic lights or at railroad crossings).

Operation and important riding points

Engine break-in EAU16842

There is never a more important period in the life of your engine than the period between 0 and 1600 km (1000 mi). For this reason, you should read the following material carefully.

Since the engine is brand new, do not put an excessive load on it for the first 1600 km (1000 mi). The various parts in the engine wear and polish themselves to the correct operating clearances. During this period, prolonged full-throttle operation or any condition that might result in engine overheating must be avoided.

1600 km (1000 mi) and beyond ECA10271

The vehicle can now be operated normally.

NOTICE

If any engine trouble should occur during the engine break-in period, immediately have a Yamaha dealer check the vehicle.

Parking EAU77860

When parking, turn off the Stop and Start System and then stop the engine. After turning off the main switch, be sure to remove the key and take it with you. For smart key models, be sure to turn off the smart key and take with you.

⚠ WARNING

- **Since the engine and exhaust system can become very hot, park in a place where pedestrians or children are not likely to touch them and be burned.**
- **Do not park on a slope or on soft ground, otherwise the vehicle may overturn, increasing the risk of a fuel leak and fire.**
- **Do not park near grass or other flammable materials which might catch fire.**
- **If the Stop and Start System is left turned on, the battery could become discharged and it may not be possible to restart the engine due to insufficient battery voltage.**

0–1000 km (0–600 mi) EAUM2012

Avoid prolonged operation above 1/3 throttle. **NOTICE: After 1000 km (600 mi) of operation, be sure to replace the engine oil and final transmission oil.** [ECA11662]

1000–1600 km (600–1000 mi)

Avoid prolonged operation above 1/2 throttle.

TIP

Even when the vehicle is parked in a location partitioned by a fence or the glass window of a shop, if the smart key is within operating range, other people will be able to start the engine and operate the vehicle. Please turn the smart key off when leaving the vehicle. (See page 4-8.)

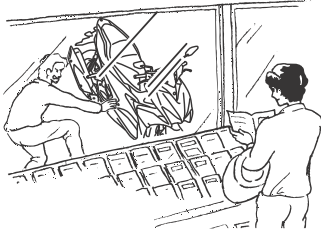

Operation and important riding points

General note

Much can be gained from the correct use and maintenance of a motorcycle.

EAUU1241

1. THE CUSTOMERS CAN USE THE FULLEST POTENTIAL OF YAMAHA MOTORCYCLES

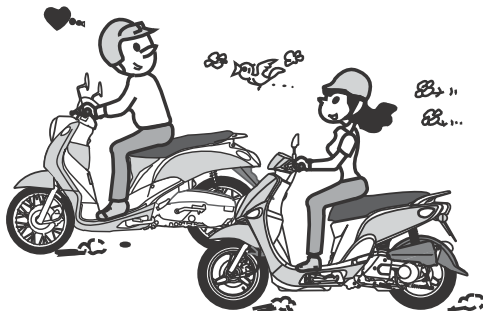

ZAUU0736

2. A MOTORCYCLE CAN KEEP ITS PERFORMANCE CAPABILITY FOR A LONGER TIME

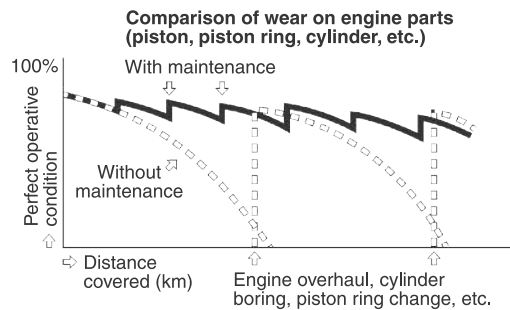

3. FUEL COST AND REPAIR EXPENSES CAN BE KEPT TO A MINIMUM

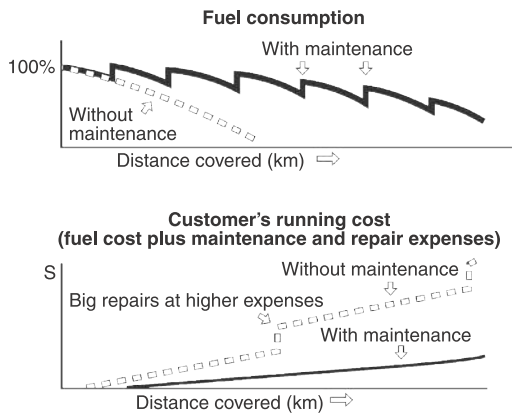

ZAUU0737

4. A MOTORCYCLE CAN DEMAND A HIGH PRICE WHEN IT IS TRADED IN AS A USED PRODUCT

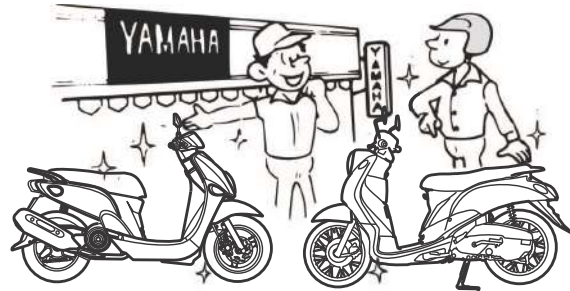

8

8-7

Periodic maintenance and adjustment

EAU17246

Periodic inspection, adjustment, and lubrication will keep your vehicle in the safest and most efficient condition possible. Safety is an obligation of the vehicle owner/operator. The most important points of vehicle inspection, adjustment, and lubrication are explained on the following pages.

The intervals given in the periodic maintenance charts should be simply considered as a general guide under normal riding conditions. However, depending on the weather, terrain, geographical location, and individual use, the maintenance intervals may need to be shortened.

EWA10322

WARNING
Failure to properly maintain the vehicle or performing maintenance activities incorrectly may increase your risk of injury or death during service or while using the vehicle. If you are not familiar with vehicle service, have a Yamaha dealer perform service.

9

EWA15123

WARNING

Turn off the engine when performing maintenance unless otherwise specified.

- A running engine has moving parts that can catch on body parts or clothing and electrical parts that can cause shocks or fires.
- Running the engine while servicing can lead to eye injury, burns, fire, or carbon monoxide poisoning – possibly leading to death. See page 2-3 for more information about carbon monoxide.

EWA15461

WARNING

Brake discs, calipers, drums, and linings can become very hot during use. To avoid possible burns, let brake components cool before touching them.

EAU39692

Owner's tool kit

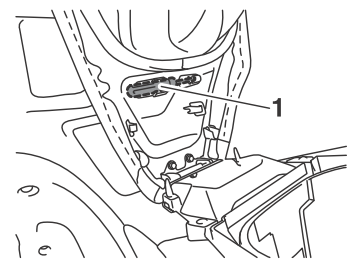

1. Owner's tool kit

The owner's tool kit is located on the bottom of the seat. (See page 6-15.) The service information included in this manual and the tools provided in the owner's tool kit are intended to assist you in the performance of preventive maintenance and minor repairs. However, additional tools such as a torque wrench may be necessary to perform certain maintenance work correctly.

TIP

If you do not have the tools or experience required for a particular job, have a Yamaha dealer perform it for you.

9-1

Periodic maintenance and adjustment

EAU46882

TIP

- The annual checks must be performed every year, except if a kilometer-based maintenance is performed instead.
- From 16000 km, repeat the maintenance intervals starting from 4000 km.
- Items marked with an asterisk should be performed by a Yamaha dealer as they require special tools, data and technical skills.

Periodic maintenance chart for the emission control system

EAU46932

NO.	ITEM	CHECK OR MAINTENANCE JOB	ODOMETER READING (whichever comes first)					ANNUAL CHECK
			1000 km or 1 month	4000 km or 4 months	7000 km or 7 months	10000 km or 10 months	13000 km or 13 months	
1	* Fuel line	• Check fuel hoses for cracks or damage.		√	√	√	√	√
2	* Fuel filter	• Check condition. • Replace if necessary.	Every 12000 km (7500 mi)					
3	Spark plug	• Check condition. • Clean and regap.		√	√	√	√	
		• Replace.	Every 10000 km (6000 mi)					
4	* Valves	• Check valve clearance. • Adjust if necessary.			√		√	
5	* Fuel injection	• Check engine idle speed.		√	√	√	√	√
6	* Exhaust system	• Check for leakage. • Tighten if necessary. • Replace gasket(s) if necessary.		√	√	√	√	√

9-2

9

Periodic maintenance and adjustment

EAUJ0284

General maintenance and lubrication chart

NO.	ITEM	CHECK OR MAINTENANCE JOB	ODOMETER READING (whichever comes first)					ANNUAL CHECK
			1000 km or 1 month	4000 km or 4 months	7000 km or 7 months	10000 km or 10 months	13000 km or 13 months	
1	* Diagnostic system check	• Perform dynamic inspection using Yamaha diagnostic tool. • Check the error codes.	√	√	√	√	√	√
2	Air filter element	• Replace.	Every 16000 km (10000 mi)					
3	Air filter check hose	• Clean.	√	√	√	√	√	
4	* V-belt case air filter element	• Clean. • Replace if necessary.		√	√	√	√	
5	* Battery	• Check voltage. • Charge if necessary.	√	√	√	√	√	√
6	Front brake	• Check operation, fluid level and vehicle for fluid leakage.	√	√	√	√	√	√
		• Replace brake pads.	Whenever worn to the limit					
7	Rear brake	• Check operation and adjust brake lever free play.	√	√	√	√	√	√
		• Replace brake shoes.	Whenever worn to the limit					
8	* Brake hoses	• Check for cracks or damage. • Check for correct routing and clamping.		√	√	√	√	√
		• Replace.	Every 4 years					
9	* Brake fluid	• Change.	Every 2 years					
10	* Wheels	• Check runout and for damage.		√	√	√	√	

9-3

9

Periodic maintenance and adjustment

NO.	ITEM	CHECK OR MAINTENANCE JOB	ODOMETER READING (whichever comes first)					ANNUAL CHECK
			1000 km or 1 month	4000 km or 4 months	7000 km or 7 months	10000 km or 10 months	13000 km or 13 months	
11 *	Tires	<ul style="list-style-type: none"> • Check tread depth and for damage. • Replace if necessary. • Check air pressure. • Correct if necessary. 		√	√	√	√	√
12 *	Wheel bearings	<ul style="list-style-type: none"> • Check bearings for looseness or damage. 		√	√	√	√	
13 *	Steering bearings	<ul style="list-style-type: none"> • Check bearing play and steering for roughness. • Lubricate with lithium-soap-based grease. 	√	√	√	√	√	
14 *	Chassis fasteners	<ul style="list-style-type: none"> • Make sure that all nuts, bolts and screws are properly tightened. 		√	√	√	√	√
15	Front brake lever pivot shaft	<ul style="list-style-type: none"> • Lubricate with silicone grease. 		√	√	√	√	√
16	Rear brake lever pivot shaft	<ul style="list-style-type: none"> • Lubricate with silicone grease. 		√	√	√	√	√
17	Sidestand, center-stand	<ul style="list-style-type: none"> • Check operation. • Lubricate with lithium-soap-based grease. 		√	√	√	√	√
18 *	Sidestand switch	<ul style="list-style-type: none"> • Check operation. 	√	√	√	√	√	√
19 *	Front fork	<ul style="list-style-type: none"> • Check operation and for oil leakage. • Change the front fork oil. 		√	√	√	√	
20 *	Shock absorber assemblies	<ul style="list-style-type: none"> • Check operation and shock absorbers for oil leakage. 		√	√	√	√	

9-4

9

Periodic maintenance and adjustment

NO.	ITEM	CHECK OR MAINTENANCE JOB	ODOMETER READING (whichever comes first)					ANNUAL CHECK	
			1000 km or 1 month	4000 km or 4 months	7000 km or 7 months	10000 km or 10 months	13000 km or 13 months		
21	Engine oil	<ul style="list-style-type: none"> • Change. • Check oil level and vehicle for oil leakage. 	√	Every 3000 km (1800 mi)					
22 *	Engine oil strainer	<ul style="list-style-type: none"> • Clean. 	√					√	
23 *	Cooling system	<ul style="list-style-type: none"> • Check coolant level and vehicle for coolant leakage. • Change with Yamaha genuine coolant. 		√	√	√	√	√	
24	Final transmission oil	<ul style="list-style-type: none"> • Check vehicle for oil leakage. • Change. 	√	√	√	√	√		
25 *	V-belt	<ul style="list-style-type: none"> • Check for damage and wear. • Replace. 			√	√	√	√	
26 *	V-belt secondary sheave	<ul style="list-style-type: none"> • Lubricate. 		Every 25000 km (15500 mi)					
27 *	Front and rear brake switches	<ul style="list-style-type: none"> • Lubricate. 		Every 12000 km (7500 mi)					
27 *	Front and rear brake switches	<ul style="list-style-type: none"> • Check operation. 	√	√	√	√	√	√	
28	Moving parts and cables	<ul style="list-style-type: none"> • Lubricate. 		√	√	√	√	√	
29 *	Throttle grip	<ul style="list-style-type: none"> • Check operation. • Check throttle grip free play, and adjust if necessary. • Lubricate cable and grip housing. 		√	√	√	√	√	
30 *	Lights, signals and switches	<ul style="list-style-type: none"> • Check operation. • Adjust headlight beam. 	√	√	√	√	√	√	

9-5

9

TIP

- Air filter
 - This model's air filter is equipped with a disposable oil-coated paper element, which must not be cleaned with compressed air to avoid damaging it.
 - The air filter element needs to be replaced more frequently when riding in unusually wet or dusty areas.
- V-belt case air filter
 - The air filter needs more frequent service if you are riding in unusually wet or dusty areas.
- Hydraulic brake service
 - Regularly check and, if necessary, correct the brake fluid level. After disassembling the brake master cylinders and calipers, always change the brake fluid.
 - Every two years replace the internal components of the brake master cylinder and caliper, and change the brake fluid.
 - Replace the brake hose every four years and if cracked or damaged.

Periodic maintenance and adjustment

Removing and installing panels EAU18773

The panels shown need to be removed to perform some of the maintenance jobs described in this chapter. Refer to this section each time a panel needs to be removed and installed.

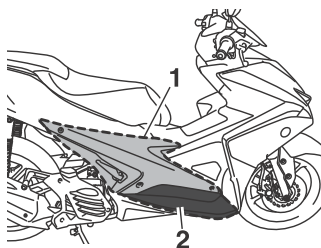

1. Panel A
2. Panel B

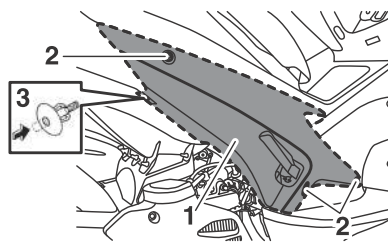

1. Panel A
2. Screw
3. Quick fastener screw

2. Extend the right passenger footrest, and then pull the panel outward.

To install the panel

1. Place the panel in the original position, and then install the screws and quick fastener screw.

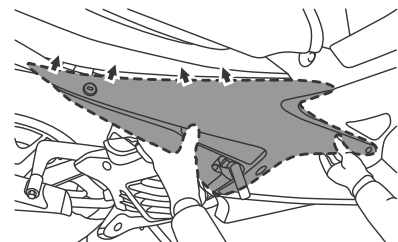

2. Retract the right passenger footrest to its original position.

Panel B

To remove the panel

1. Remove panel A.
2. Remove the right floorboard mat by pulling it up.
3. Remove the screws and bolts, and then pull the panel outward.

Panel A

To remove the panel

1. Remove the screws and quick fastener screw.

Periodic maintenance and adjustment

EAUT2075

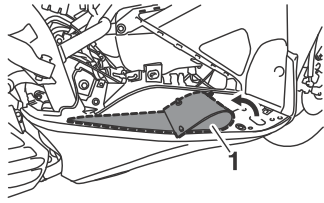

1. Floorboard mat

2. Place the right floorboard mat in the original position and push it downward to secure it.
3. Install panel A.

To install the panel

1. Place the panel in the original position, and then install the screws and bolts.

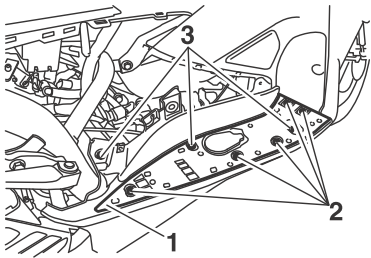

1. Panel B
2. Screw
3. Bolt

Checking the spark plug

The spark plug is an important engine component, which is easy to check. Since heat and deposits will cause any spark plug to slowly erode, the spark plug should be removed and checked in accordance with the periodic maintenance and lubrication chart. In addition, the condition of the spark plug can reveal the condition of the engine.

To remove the spark plug

1. Remove panel A. (See page 9-7.)
2. Remove the spark plug cap.

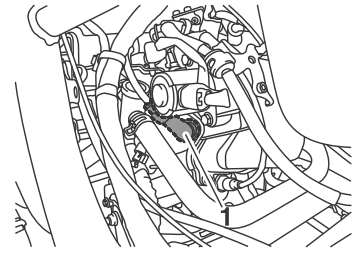

1. Spark plug cap

3. Remove the spark plug as shown, with a spark plug wrench available at a Yamaha dealer.

9

9-8

Periodic maintenance and adjustment

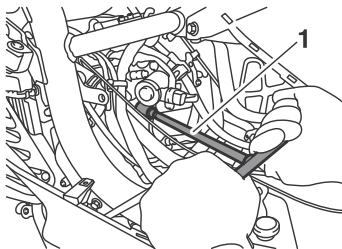

1. Spark plug wrench

To check the spark plug

1. Check that the porcelain insulator around the center electrode of the spark plug is a medium-to-light tan (the ideal color when the vehicle is ridden normally).

TIP

If the spark plug shows a distinctly different color, the engine could be operating improperly. Do not attempt to diagnose such problems yourself. Instead, have a Yamaha dealer check the vehicle.

2. Check the spark plug for electrode erosion and excessive carbon or other deposits, and replace it if necessary.

Specified spark plug:

NGK/CPR8EA9
DENSO/U24EPR-9

3. Measure the spark plug gap with a wire thickness gauge and, if necessary, adjust the gap to specification.

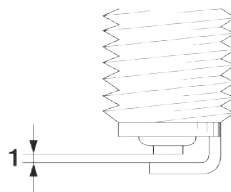

1. Spark plug gap

Spark plug gap:

0.8–0.9 mm (0.031–0.035 in)

To install the spark plug

1. Clean the surface of the spark plug gasket and its mating surface, and then wipe off any grime from the spark plug threads.
2. Install the spark plug with the spark plug wrench, and then tighten it to the specified torque.

Tightening torque:

Spark plug:
13 N·m (1.3 kgf·m, 9.4 lb·ft)

TIP

If a torque wrench is not available when installing a spark plug, a good estimate of the correct torque is 1/4–1/2 turn past finger tight. However, the spark plug should be tightened to the specified torque as soon as possible.

3. Install the spark plug cap.

9

9-9

Periodic maintenance and adjustment

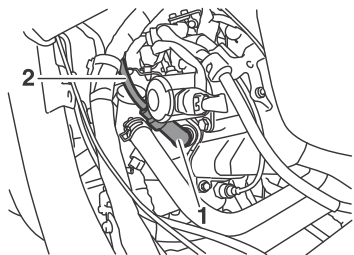

1. Spark plug cap
2. Spark plug lead
4. Install the panel.

EUAU62845

Engine oil and oil strainer

The engine oil level should be checked before each ride. In addition, the oil must be changed and the oil strainer cleaned at the intervals specified in the periodic maintenance and lubrication chart.

To check the engine oil level

1. Place the vehicle on the center-stand. A slight tilt to the side can result in a false reading.
2. Start the engine, warm it up for several minutes, and then turn it off.
3. Wait a few minutes until the oil settles, remove the oil filler cap, wipe the dipstick clean, insert it back into the oil filler hole (without screwing it in), and then remove it again to check the oil level.

WARNING

The muffler and muffler protector become very hot during use. To avoid possible burns, let the muffler and protector cool before removing the oil filler cap.

EWAU0031

TIP

The engine oil should be between the tip of the dipstick and maximum level mark.

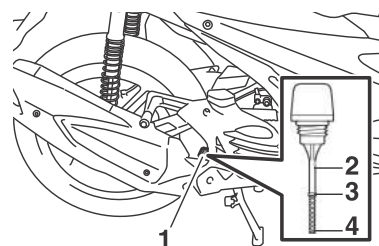

1. Engine oil filler cap
2. Engine oil dipstick
3. Maximum level mark
4. Tip of the engine oil dipstick

4. If the engine oil is at or below the minimum level mark, add sufficient oil of the recommended type to raise it to the correct level.
5. Insert the dipstick into the oil filler hole, and then tighten the oil filler cap.

9

9-10

Periodic maintenance and adjustment

To change the engine oil and clean the oil strainer

1. Start the engine, warm it up for several minutes, and then turn it off.
2. Place an oil pan under the engine to collect the used oil.
3. Remove the engine oil filler cap and drain bolt B to drain the oil from the crankcase. **NOTICE: When removing the engine oil drain bolt, the O-ring, compression spring, and oil strainer will fall out. Take care not to lose these parts.** [ECA11002]

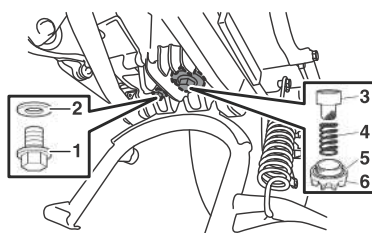

1. Engine oil drain bolt A
2. Gasket
3. Oil strainer
4. Compression spring
5. O-ring
6. Engine oil drain bolt B

TIP

When only changing the engine oil, remove drain bolt A. When changing the engine oil and cleaning the engine oil strainer, remove drain bolt B also.

4. Clean the engine oil strainer with solvent, and then check it for damage and replace it if necessary.

5. Install the engine oil strainer, compression spring, engine oil drain bolt with new O-ring, and then tighten the drain bolt to the specified torque.

TIP

Make sure that the O-ring is properly seated.

Tightening torque:

- Engine oil drain bolt A:
20 N·m (2.0 kgf·m, 14 lb·ft)
- Engine oil drain bolt B:
32 N·m (3.2 kgf·m, 23 lb·ft)

6. Refill with the specified amount of the recommended engine oil, and then install and tighten the oil filler cap.

Recommended engine oil:

- See page 11-1.
- Oil quantity:**
0.90 L (0.95 US qt, 0.79 Imp.qt)

TIP

Be sure to wipe off spilled oil on any parts after the engine and exhaust system have cooled down.

9

9-11

Periodic maintenance and adjustment

NOTICE

- Do not use oils with a diesel specification of "CD" or oils of a higher quality than specified. In addition, do not use oils labeled "ENERGY CONSERVING II" or higher.
- Be sure no foreign material enters the crankcase.

7. Start the engine, and then let it idle for several minutes while checking it for oil leakage. If oil is leaking, immediately turn the engine off and check for the cause.
8. Turn the engine off, and then check the oil level and correct it if necessary.

ECA11671

Final transmission oil

The final transmission case must be checked for oil leakage before each ride. If any leakage is found, have a Yamaha dealer check and repair your motorcycle. In addition, the final transmission oil must be changed as follows at the intervals specified in the periodic maintenance and lubrication chart.

1. Start the engine and warm up the final transmission oil by riding the motorcycle for several minutes.
2. Stop the engine and then place the motorcycle on the center-stand.
3. Place an oil pan under the final transmission case to collect the used oil.
4. Remove the final transmission oil filler cap and its O-ring from the final transmission case.

EAU67820

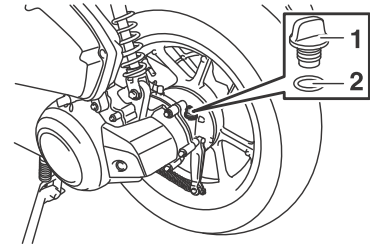

1. Final transmission oil filler cap
2. O-ring

5. Remove the final transmission oil drain bolt and its gasket to drain the oil from the final transmission case.

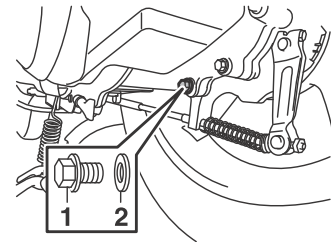

1. Final transmission oil drain bolt
2. Gasket

9

9-12

Periodic maintenance and adjustment

6. Install the final transmission oil drain bolt and its new gasket, and then tighten the bolt to the specified torque.

Tightening torque:

Final transmission oil drain bolt:
20 N·m (2.0 kgf·m, 14 lb·ft)

7. Refill with the specified amount of the recommended final transmission oil. **WARNING! Make sure that no foreign material enters the final transmission case. Make sure that no oil gets on the tire or wheel.** [EWA11312]

Recommended final transmission oil:

See page 11-1.

Oil quantity:
0.15 L (0.16 US qt, 0.13 Imp.qt)

8. Install the final transmission oil filler cap and its new O-ring, and then tighten the oil filler cap.
9. Check the final transmission case for oil leakage. If oil is leaking, check for the cause.

Coolant

The coolant level should be checked before each ride. In addition, the coolant must be changed at the intervals specified in the periodic maintenance and lubrication chart.

EAU20071

To check the coolant level

1. Place the vehicle on the center-stand.

TIP

- The coolant level must be checked on a cold engine since the level varies with engine temperature.
- Make sure that the vehicle is positioned straight up when checking the coolant level. A slight tilt to the side can result in a false reading.

2. Check the coolant level through the check window.

TIP

The coolant should be between the minimum and maximum level marks.

EAU67000

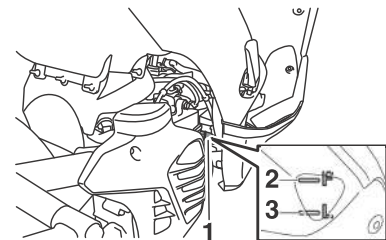

1. Coolant level check window
2. Maximum level mark
3. Minimum level mark

3. If the coolant is at or below the minimum level mark, remove the right floorboard mat by pulling it up.

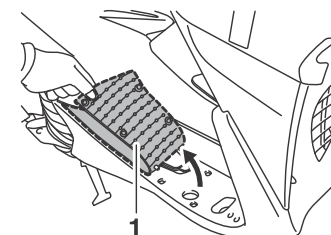

1. Floorboard mat

9

9-13

Periodic maintenance and adjustment

EAU33032

- Remove the coolant reservoir cover.

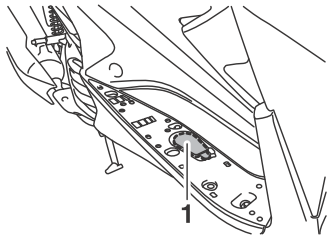

1. Coolant reservoir cover

- Remove the coolant reservoir cap, add coolant to the maximum level mark, and then install the reservoir cap. **WARNING! Remove only the coolant reservoir cap. Never attempt to remove the radiator cap when the engine is hot.** [EWA15162] **NOTICE: If coolant is not available, use distilled water or soft tap water instead. Do not use hard water or salt water since it is harmful to the engine. If water has been used instead of coolant, replace it with coolant as soon as possible, otherwise the cooling system will not**

be protected against frost and corrosion. If water has been added to the coolant, have a Yamaha dealer check the anti-freeze content of the coolant as soon as possible, otherwise the effectiveness of the coolant will be reduced. [ECA10473]

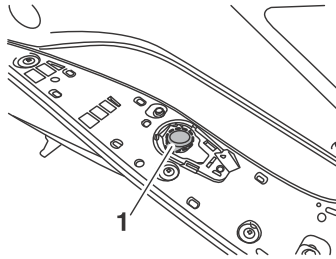

1. Coolant reservoir cap

Recommended coolant:
YAMAHA GENUINE COOLANT
Coolant reservoir capacity (up to the maximum level mark):
0.13 L (0.14 US qt, 0.11 Imp.qt)

- Install the coolant reservoir cover.
- Place the right floorboard mat in the original position and push it downward to secure it.

9-14

Changing the coolant

The coolant must be changed at the intervals specified in the periodic maintenance and lubrication chart. Have a Yamaha dealer change the coolant. **WARNING! Never attempt to remove the radiator cap when the engine is hot.** [EWA10382]

9

Periodic maintenance and adjustment

EAU67174

Air filter and V-belt case air filter elements

The air filter element should be replaced and the V-belt case air filter element should be cleaned at the intervals specified in the periodic maintenance and lubrication chart. Service the air filter elements more frequently if you are riding in unusually wet or dusty areas. The air filter check hose and V-belt case air filter check hose must be frequently checked and cleaned if necessary.

Cleaning the air filter check hose

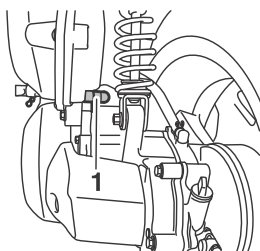

1. Air filter check hose

- Check the hose on the rear side of the air filter case for accumulated dirt or water.
- If dirt or water is visible, remove the hose from the clamp, clean it, and then install it.

TIP

If dirt or water was found in the check hose, be sure to check the air filter element for excessive dirt or damage and replace it if necessary.

Replacing the air filter element

- Place the vehicle on the center-stand.
- Remove the air filter case cover by removing the screws.

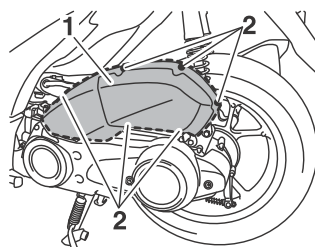

1. Air filter case cover
2. Screw

9-15

- Pull the air filter element out.

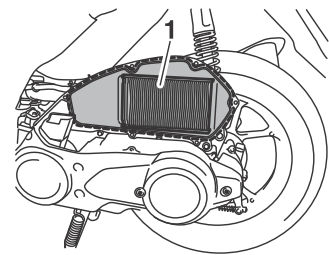

1. Air filter element

- Insert a new air filter element into the air filter case. **NOTICE: Make sure that the air filter element is properly seated in the air filter case. The engine should never be operated without the air filter element installed, otherwise the piston(s) and/or cylinder(s) may become excessively worn.**

[ECA10482]

ECA21220

NOTICE

- ☒ The air filter element must be replaced at the intervals specified in the periodic maintenance and lubrication chart.

9

Periodic maintenance and adjustment

- The air filter element needs more frequent replacement if you are riding in unusually wet or dusty areas.
- Do not clean the air filter element by blowing it with compressed air.

5. Install the air filter case cover by installing the screws.

Cleaning the V-belt case check hose

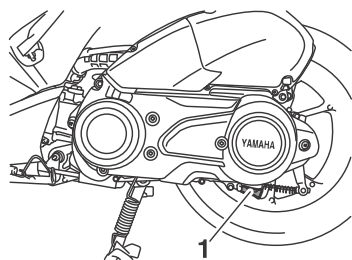

1. V-belt case check hose

1. Check the hose on the rear side of the V-belt case for accumulated dirt or water.
2. If dirt or water is visible, remove the hose from the clamp, clean it, and then install it.

TIP

If dirt or water was found in the check hose, be sure to check the V-belt case air filter element for excessive dirt or damage and clean or replace it if necessary.

Cleaning the V-belt case air filter element

1. Place the vehicle on the center-stand.
2. Remove the screws, and then pull the V-belt case air filter element cover outward and away from the V-belt case.

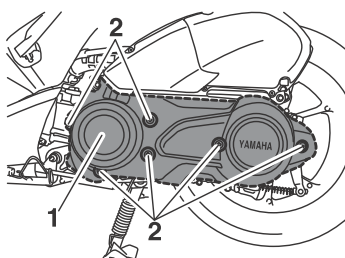

1. V-belt case air filter element cover
2. Screw

3. Pull the V-belt case air filter element out, and then clean it with solvent. After cleaning, remove the remaining solvent by squeezing the element. **WARNING! Use only a dedicated parts cleaning solvent. To avoid the risk of fire or explosion, do not use gasoline or solvents with a low flash point.** [EWA10432] **NOTICE: To avoid damaging the air filter element, handle it gently and carefully, and do not twist it.** [ECA10522]

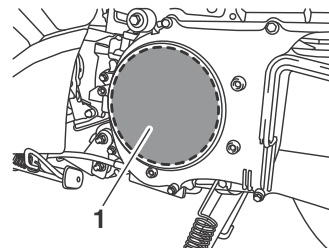

1. V-belt case air filter element

Periodic maintenance and adjustment

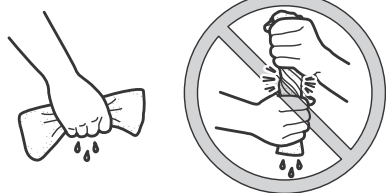

4. Apply oil of the recommended type to the entire surface of the sponge material, and then squeeze the excess oil out.

TIP

- The air filter element should be wet but not dripping.
- Check the air filter element for excessive dirt or damage and replace it if necessary.

Recommended oil:

Yamaha foam air filter oil or other quality foam air filter oil

5. Insert the element into the V-belt case.
6. Install the air filter element cover by installing the screws.

Checking the throttle grip free play

EAU21386

Measure the throttle grip free play as shown.

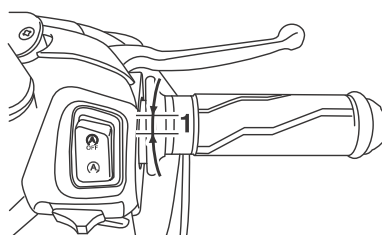

1. Throttle grip free play

Throttle grip free play:
3.0–5.0 mm (0.12–0.20 in)

Periodically check the throttle grip free play and, if necessary, have a Yamaha dealer adjust it.

Valve clearance

EAU21402

The valve clearance changes with use, resulting in improper air-fuel mixture and/or engine noise. To prevent this from occurring, the valve clearance must be adjusted by a Yamaha dealer at the intervals specified in the periodic maintenance and lubrication chart.

Periodic maintenance and adjustment

Tires

EAU64401

Tires are the only contact between the vehicle and the road. Safety in all conditions of riding depends on a relatively small area of road contact. Therefore, it is essential to maintain the tires in good condition at all times and replace them at the appropriate time with the specified tires.

Tire air pressure

The tire air pressure should be checked and, if necessary, adjusted before each ride.

EWA10504

WARNING

Operation of this vehicle with improper tire pressure may cause severe injury or death from loss of control.

- The tire air pressure must be checked and adjusted on cold tires (i.e., when the temperature of the tires equals the ambient temperature).
- The tire air pressure must be adjusted in accordance with the riding speed and with the total

weight of rider, passenger, cargo, and accessories approved for this model.

Tire air pressure (measured on cold tires):

1 person:

Front:
200 kPa (2.00 kgf/cm², 29 psi)
Rear:
225 kPa (2.25 kgf/cm², 33 psi)

2 persons:

Front:
200 kPa (2.00 kgf/cm², 29 psi)
Rear:
225 kPa (2.25 kgf/cm², 33 psi)

Maximum load*:

153 kg (337 lb) (GDR155-A)

* Total weight of rider, passenger, cargo and accessories

EWA10512

WARNING

Never overload your vehicle. Operation of an overloaded vehicle could cause an accident.

Tire inspection

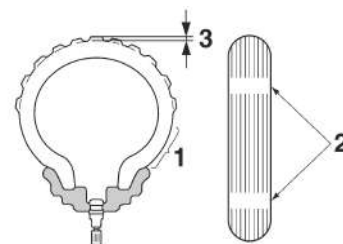

1. Tire sidewall
2. Tire wear indicator
3. Tire tread depth

The tires must be checked before each ride. If a tire tread shows crosswise lines (minimum tread depth), if the tire has a nail or glass fragments in it, or if the sidewall is cracked, contact a Yamaha dealer immediately and have the tire replaced.

Minimum tire tread depth (front and rear):

1.0 mm (0.04 in)

9

9-18

Periodic maintenance and adjustment

WARNING

EWA10583

- It is dangerous to ride with a worn-out tire. When a tire tread begins to show crosswise lines, have a Yamaha dealer replace the tire immediately.
- The replacement of all wheel and brake-related parts, including the tires, should be left to a Yamaha dealer, who has the necessary professional knowledge and experience to do so.
- Ride at moderate speeds after changing a tire since the tire surface must first be "broken in" for it to develop its optimal characteristics.

Tire information

This model is equipped with tubeless tires and tire air valves.

Tires age, even if they have not been used or have only been used occasionally. Cracking of the tread and sidewall rubber, sometimes accompanied by carcass deformation, is an evidence of

ageing. Old and aged tires shall be checked by tire specialists to ascertain their suitability for further use.

EWA10462

WARNING

The front and rear tires should be of the same make and design, otherwise the handling characteristics of the vehicle may be different, which could lead to an accident.

After extensive tests, only the tires listed below have been approved for this model by Yamaha.

Front tire:

Size:
110/80-14M/C 53P
Manufacturer/model:
IRC/SCT-005F

Rear tire:

Size:
140/70-14M/C 62P
Manufacturer/model:
IRC/SCT-005R

Cast wheels

EAU21963

To maximize the performance, durability, and safe operation of your vehicle, note the following points regarding the specified wheels.

- The wheel rims should be checked for cracks, bends, warp-age or other damage before each ride. If any damage is found, have a Yamaha dealer replace the wheel. Do not attempt even the smallest repair to the wheel. A deformed or cracked wheel must be replaced.
- The wheel should be balanced whenever either the tire or wheel has been changed or replaced. An unbalanced wheel can result in poor performance, adverse handling characteristics, and a shortened tire life.

9

9-19

Periodic maintenance and adjustment

Checking the front brake lever free play EAU49351

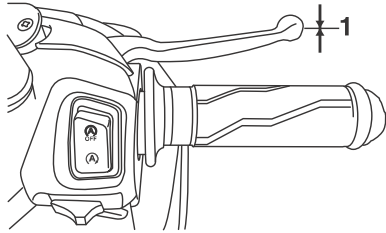

1. No brake lever free play

There should be no free play at the brake lever end. If there is free play, have a Yamaha dealer inspect the brake system.

⚠ WARNING

A soft or spongy feeling in the brake lever can indicate the presence of air in the hydraulic system. If there is air in the hydraulic system, have a Yamaha dealer bleed the system before operating the vehicle. Air in the hydraulic system will diminish the

braking performance, which may result in loss of control and an accident.

Adjusting the rear brake lever free play EAU22172

Measure the rear brake lever free play as shown.

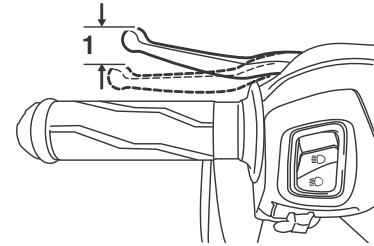

1. Rear brake lever free play

Rear brake lever free play:
10.0–20.0 mm (0.39–0.79 in)

Periodically check the brake lever free play and, if necessary, adjust it as follows.

To increase the brake lever free play, turn the adjusting nut at the brake shoe plate in direction (a). To decrease the brake lever free play, turn the adjusting nut in direction (b).

9

9-20

Periodic maintenance and adjustment

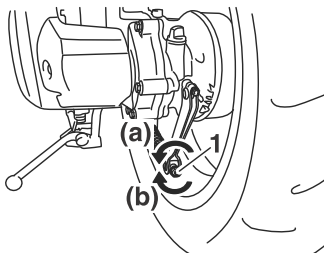

1. Rear brake lever free play adjusting nut

⚠ WARNING

If proper adjustment cannot be obtained as described, have a Yamaha dealer make this adjustment.

Checking the front brake pads and rear brake shoes EAU22382

The front brake pads and the rear brake shoes must be checked for wear at the intervals specified in the periodic maintenance and lubrication chart.

Front brake pads EAU22432

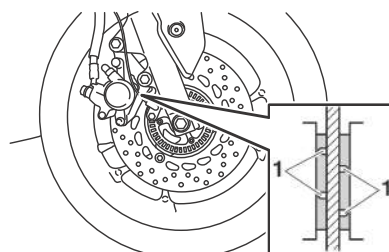

1. Brake pad wear indicator groove

Each front brake pad is provided with wear indicator grooves, which allow you to check the brake pad wear without having to disassemble the brake. To check the brake pad wear, check the wear indicator grooves. If a brake pad has worn to the point that the wear

indicator grooves have almost disappeared, have a Yamaha dealer replace the brake pads as a set.

Rear brake shoes EAU22541

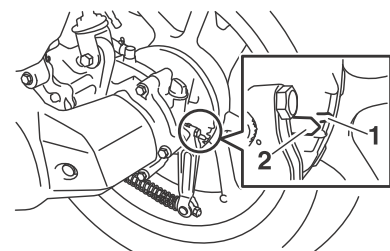

1. Brake shoe wear indicator
2. Brake shoe wear limit line

The rear brake is provided with a wear indicator, which allows you to check the brake shoe wear without having to disassemble the brake. To check the brake shoe wear, check the position of the wear indicator while applying the brake. If a brake shoe has worn to the point that the wear indicator reaches the wear limit line, have a Yamaha dealer replace the brake shoes as a set.

9

9-21

Periodic maintenance and adjustment

Checking the brake fluid level EAU77811

Before starting off, confirm that the brake fluid is above the minimum level mark. (Position the handlebars so the brake fluid in the reservoir is level to the ground.) Replenish the brake fluid if necessary.

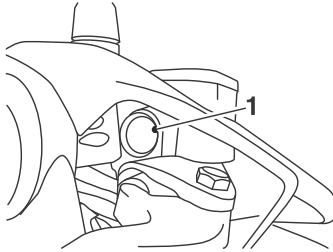

1. Minimum level mark

Specified brake fluid:

YAMAHA GENUINE BRAKE FLUID:
DOT 4-Plus (GDR155-A)

WARNING

Improper maintenance can result in loss of braking ability. Observe these precautions:

- Insufficient brake fluid may allow air to enter the brake system, reducing braking performance.
- Do not let water enter the brake fluid reservoir when refilling. Water will significantly lower the boiling point of the fluid and may result in vapor lock.
- To prevent contamination, clean the reservoir and filler cap before removing. Use only fresh brake fluid from a sealed container.
- Use only the specified brake fluid. Use of a different brake fluid may result in a harmful chemical reaction, may cause the rubber seals to deteriorate or cause internal rusting of the brake system.

As the brake pads wear, it is normal for the brake fluid level to gradually go down. A low brake fluid level may indicate worn brake pads or brake system leakage. Therefore, be sure to check the brake pads for wear and the brake system for leakage. If the brake fluid level goes down suddenly, have a Yamaha dealer check the vehicle before further operation.

NOTICE

Brake fluid may damage painted surfaces or plastic parts. Always clean up spilled fluid immediately.

9-22

9

Periodic maintenance and adjustment

Changing the brake fluid EAU22724

Have a Yamaha dealer change the brake fluid at the intervals specified in the periodic maintenance and lubrication chart. In addition, have the oil seals of the brake master cylinder and caliper as well as the brake hose replaced at the intervals listed below or whenever they are damaged or leaking.

- Oil seals: Replace every two years.
- Brake hose: Replace every four years.

Checking the V-belt EAU00311

The V-belt must be checked and replaced by a Yamaha dealer at the intervals specified in the periodic maintenance and lubrication chart.

Checking and lubricating the cables EAU23098

The operation of all control cables and the condition of the cables should be checked before each ride, and the cables and cable ends should be lubricated if necessary. If a cable is damaged or does not move smoothly, have a Yamaha dealer check or replace it. **WARNING! Damage to the outer housing of cables may result in internal rusting and cause interference with cable movement. Replace damaged cables as soon as possible to prevent unsafe conditions.** [EWA10712]

Recommended lubricant:

Yamaha cable lubricant or other suitable cable lubricant

9

9-23

Periodic maintenance and adjustment

Checking and lubricating the throttle grip and cable

EAU49921

The operation of the throttle grip should be checked before each ride. In addition, the cable should be lubricated by a Yamaha dealer at the intervals specified in the periodic maintenance chart.

Lubricating the front and rear brake levers

EAU43643

The pivoting points of the front and rear brake levers must be lubricated at the intervals specified in the periodic maintenance and lubrication chart.

Recommended lubricants:

Front brake lever:
Silicone grease
Rear brake lever:
Lithium-soap-based grease

Front brake lever

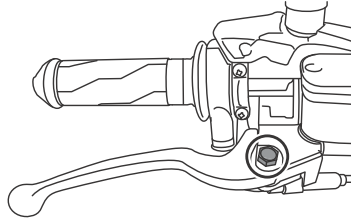

Rear brake lever

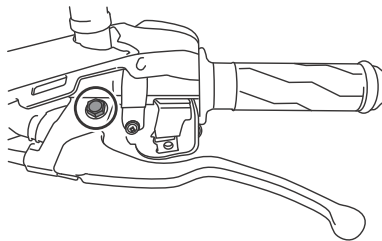

9-24

9

Periodic maintenance and adjustment

Checking and lubricating the centerstand and sidestand

EAU23215

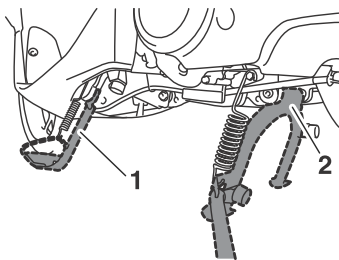

1. Sidestand
2. Centerstand

The operation of the centerstand and sidestand should be checked before each ride, and the pivots and metal-to-metal contact surfaces should be lubricated if necessary.

EWA10742

Recommended lubricant:
Lithium-soap-based grease

Checking the front fork

EAU23273

The condition and operation of the front fork must be checked as follows at the intervals specified in the periodic maintenance and lubrication chart.

To check the condition

Check the inner tubes for scratches, damage and excessive oil leakage.

To check the operation

1. Place the vehicle on a level surface and hold it in an upright position. **WARNING! To avoid injury, securely support the vehicle so there is no danger of it falling over.** [EWA10752]
2. While applying the front brake, push down hard on the handlebars several times to check if the front fork compresses and rebounds smoothly.

9

WARNING

If the centerstand or sidestand does not move up and down smoothly, have a Yamaha dealer check or repair it. Otherwise, the centerstand or sidestand could contact the ground and distract the operator, resulting in a possible loss of control.

9-25

Periodic maintenance and adjustment

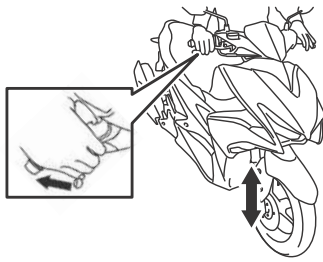

ECA10591

NOTICE

If any damage is found or the front fork does not operate smoothly, have a Yamaha dealer check or repair it.

Checking the steering

Worn or loose steering bearings may cause danger. Therefore, the operation of the steering must be checked as follows at the intervals specified in the periodic maintenance and lubrication chart.

1. Place the vehicle on the center-stand. **WARNING! To avoid injury, securely support the vehicle so there is no danger of it falling over.** [EWA10752]
2. Hold the lower ends of the front fork legs and try to move them forward and backward. If any free play can be felt, have a Yamaha dealer check or repair the steering.

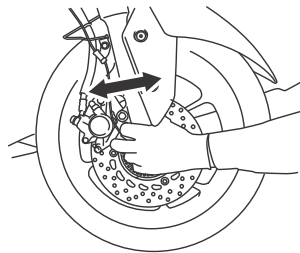

9-26

EAU45512

Checking the wheel bearings

EAU23292

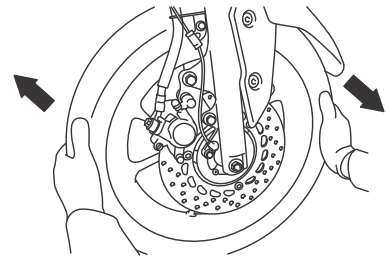

The front and rear wheel bearings must be checked at the intervals specified in the periodic maintenance and lubrication chart. If there is play in the wheel hub or if the wheel does not turn smoothly, have a Yamaha dealer check the wheel bearings.

9

Periodic maintenance and adjustment

Battery

EAU50292

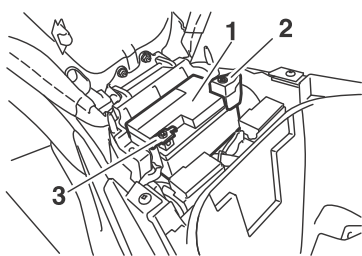

1. Battery
2. Positive battery lead (red)
3. Negative battery lead (black)

The battery is located under the seat. (See page 6-15.)

This model is equipped with a VRLA (Valve Regulated Lead Acid) battery. There is no need to check the electrolyte or to add distilled water. However, the battery lead connections need to be checked and, if necessary, tightened.

EWA10761

WARNING

- **Electrolyte is poisonous and dangerous since it contains sulfuric acid, which causes severe**

burns. Avoid any contact with skin, eyes or clothing and always shield your eyes when working near batteries. In case of contact, administer the following FIRST AID.

- **EXTERNAL:** Flush with plenty of water.
- **INTERNAL:** Drink large quantities of water or milk and immediately call a physician.
- **EYES:** Flush with water for 15 minutes and seek prompt medical attention.
- **Batteries produce explosive hydrogen gas. Therefore, keep sparks, flames, cigarettes, etc., away from the battery and provide sufficient ventilation when charging it in an enclosed space.**
- **KEEP THIS AND ALL BATTERIES OUT OF THE REACH OF CHILDREN.**

To charge the battery

Have a Yamaha dealer charge the battery as soon as possible if it seems to have discharged. Keep in mind that the

battery tends to discharge more quickly if the vehicle is equipped with optional electrical accessories.

ECA16522

NOTICE

To charge a VRLA (Valve Regulated Lead Acid) battery, a special (constant-voltage) battery charger is required. Using a conventional battery charger will damage the battery.

To store the battery

1. If the vehicle will not be used for more than one month, remove the battery, fully charge it, and then place it in a cool, dry place. **NOTICE:** When removing the battery, be sure to turn the main switch off, then disconnect the negative lead before disconnecting the positive lead. [ECA16304]
2. If the battery will be stored for more than two months, check it at least once a month and fully charge it if necessary.
3. Fully charge the battery before installation. **NOTICE:** When installing the battery, be sure to turn the main switch off, then con-

9-27

nect the positive lead before connecting the negative lead.

[ECA16842]

4. After installation, make sure that the battery leads are properly connected to the battery terminals.

ECA16531

NOTICE

Always keep the battery charged. Storing a discharged battery can cause permanent battery damage.

Replacing the fuses

EAU66795

The fuse boxes, which contain the fuses for the individual circuits, are located under the seat. (See page 6-15.)

(GDR155-A)

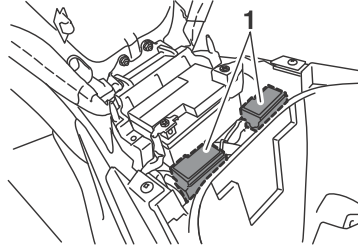

1. Fuse box

Periodic maintenance and adjustment

(GDR155-A)

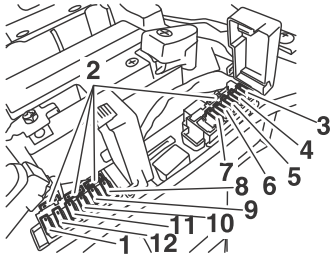

1. Main fuse
2. Spare fuse
3. Fuel injection system fuse
4. Backup fuse
5. Ignition fuse
6. Headlight fuse
7. Signaling system fuse
8. ABS solenoid fuse
9. ABS motor fuse
10. ABS control unit fuse
11. Smart key system fuse
12. Terminal fuse 1 (for auxiliary DC jack)

If a fuse is blown, replace it as follows.

1. Turn off the electrical circuit in question, and then turn off the main switch.
2. Open the seat. (See page 6-15.)
3. Remove the battery cover by removing the screws.

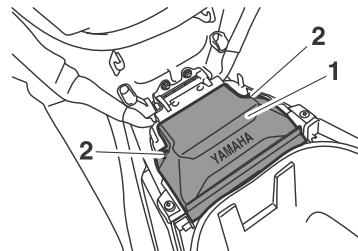

1. Battery cover
2. Screw

4. Remove the blown fuse, and then install a new fuse of the specified amperage. **WARNING! Do not use a fuse of a higher amperage rating than recommended to avoid causing extensive damage to the electrical system and possibly a fire.** [EWA15132]

Specified fuses:

- Main fuse: 30.0 A
- Terminal fuse 1: 2.0 A
- Headlight fuse: 7.5 A
- Signaling system fuse: 7.5 A
- Ignition fuse: 7.5 A
- Smart key system fuse: 2.0 A (GDR155-A)
- ABS motor fuse: 10.0 A (GDR155-A)
- Fuel injection system fuse: 7.5 A
- ABS solenoid fuse: 7.5 A (GDR155-A)
- ABS control unit fuse: 2.0 A (GDR155-A)
- Backup fuse: 7.5 A

5. Turn the main switch on, and then turn on the electrical circuit in question to check if the device operates.

Periodic maintenance and adjustment

TIP

If the fuse immediately blows again, have a Yamaha dealer check the electrical system.

6. Install the battery cover by installing the screws.
7. Close the seat.

Headlight

This model is equipped with an LED-type headlight. If a headlight does not come on, have a Yamaha dealer check its electrical circuit.

NOTICE

Do not affix any type of tinted film or stickers to the headlight lens.

EAU62850

ECA16581

Replacing an auxiliary light bulb

This model is equipped with two auxiliary lights. If an auxiliary light bulb burns out, replace it as follows.

1. Place the vehicle on the center-stand.
2. Remove the auxiliary light bulb socket (together with the bulb) by turning the socket counterclockwise.

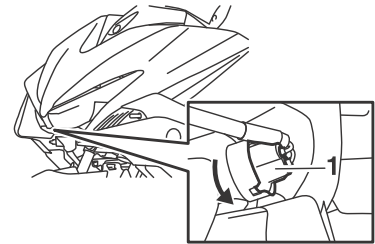

1. Auxiliary light bulb socket

3. Remove the burnt-out bulb by pulling it out.

9

9-30

Periodic maintenance and adjustment

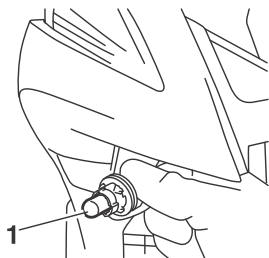

1. Auxiliary light bulb

4. Insert a new bulb into the socket.
5. Install the socket (together with the bulb) by turning it clockwise.

Tail/brake light

This model is equipped with an LED-type tail/brake light. If the tail/brake light does not come on, have a Yamaha dealer check it.

EAU24182

Replacing a front turn signal light bulb

1. Place the vehicle on the center-stand.
2. Remove the turn signal light bulb socket (together with the bulb) by turning it counterclockwise.

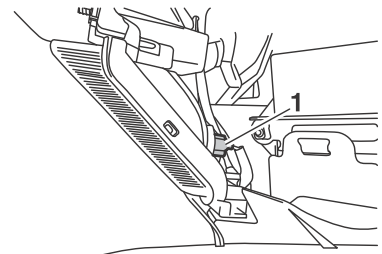

1. Turn signal light bulb socket

3. Remove the burnt-out bulb by pulling it out.

9

9-31

Periodic maintenance and adjustment

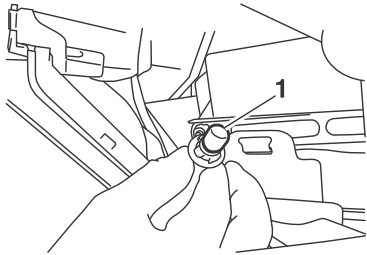

1. Turn signal light bulb

4. Insert a new bulb into the socket.
5. Install the socket (together with the bulb) by turning it clockwise.

Replacing a rear turn signal light bulb

EAUM1454

1. Remove the turn signal light unit by removing the screw.

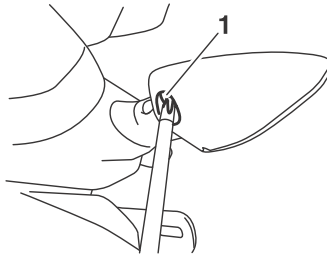

1. Screw

2. Remove the socket (together with the turn signal light bulb) by turning it counterclockwise.
3. Remove the burnt-out bulb by pulling it outward.

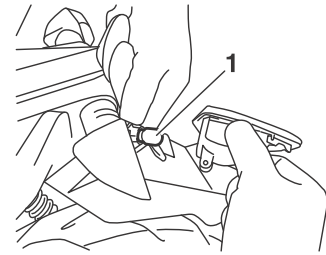

1. Turn signal light bulb

4. Insert a new bulb into the socket.
5. Install the socket (together with the bulb) by turning it clockwise.
6. Install the turn signal light unit by installing the screw.

9

9-32

Periodic maintenance and adjustment

Replacing the license plate light bulb

1. Remove the license plate light unit by removing the screw.

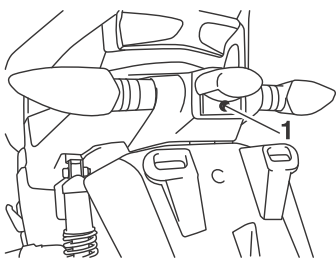

1. Screw

2. Remove the license plate light bulb socket (together with the bulb) by pulling it out.

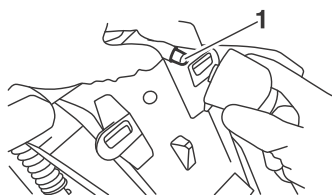

1. License plate light bulb

3. Remove the burnt-out bulb by pulling it out.
4. Insert a new bulb into the socket.
5. Install the socket (together with the bulb) by pushing it in.
6. Install the license plate light unit by installing the screw.

Troubleshooting

EAU60701

Although Yamaha vehicles receive a thorough inspection before shipment from the factory, trouble may occur during operation. Any problem in the fuel, compression, or ignition systems, for example, can cause poor starting and loss of power.

The following troubleshooting charts represent quick and easy procedures for checking these vital systems yourself. However, should your vehicle require any repair, take it to a Yamaha dealer, whose skilled technicians have the necessary tools, experience, and know-how to service the vehicle properly.

Use only genuine Yamaha replacement parts. Imitation parts may look like Yamaha parts, but they are often inferior, have a shorter service life and can lead to expensive repair bills.

EWA15142

WARNING

When checking the fuel system, do not smoke, and make sure there are no open flames or sparks in the area, including pilot lights from water

9

9-33

Periodic maintenance and adjustment

heaters or furnaces. Gasoline or gasoline vapors can ignite or explode, causing severe injury or property damage.

Smart key system troubleshooting (GDR155-A)

EAU76550

Please check the following items when the smart key system does not work.

- Is the smart key turned on? (See page 4-5.)
- Is the smart key battery discharged? (See page 4-6.)
- Is the smart key battery installed correctly? (See page 4-6.)
- Is the smart key being used in a location with strong radio waves or other electromagnetic noise? (See page 4-1.)
- Are you using the smart key that is registered to the vehicle?
- Is the vehicle battery discharged? When the vehicle battery is discharged, the smart key system will not operate. Please have the vehicle battery charged or replaced. (See page 9-27.)

If the smart key system does not work after checking the above items, have a Yamaha dealer check the smart key system.

TIP

See “Emergency mode” on page 9-38 for information on starting the engine without the smart key.

EAU76843

Stop and Start System troubleshooting (GDR155-A)

If a problem occurs, check the following before taking the vehicle to a Yamaha dealer.

The Stop and Start System indicator light does not come on.

1. Is the main switch turned on?
2. Is the Stop and Start System switch set to “**A**”?
3. Was the engine warmed up sufficiently after starting?
4. After the engine was warmed up, was the engine left idling for a certain period of time?
5. Did the vehicle travel at a speed of 10 km/h or higher?

9-34

Even if the preceding conditions are met, the Stop and Start System may not activate in order to preserve battery power. In this case, continue to drive the vehicle.

In addition, the Stop and Start System indicator light does not come on if the engine trouble warning light is on.

If the Stop and Start System indicator light still does not come on after you checked the preceding conditions, have a Yamaha dealer check the vehicle as soon as possible.

The Stop and Start System indicator light comes on, but the engine does not stop automatically.

1. Was the vehicle stopped completely?
The engine may not stop automatically until the vehicle is stopped for a certain period of time. Try bringing the vehicle to a complete stop.
2. Is the throttle grip turned?
The engine does not stop automatically if the throttle grip is not in the fully closed position.

9

Periodic maintenance and adjustment

Turn the throttle grip to the fully closed position.

If the engine still does not stop automatically after you checked the preceding conditions, have a Yamaha dealer check the vehicle as soon as possible.

After the engine was stopped by the Stop and Start System, the engine does not restart even if the throttle grip is turned.

1. Is the Stop and Start System switch set to “**A**”?

If the Stop and Start System switch is set to “**A**” while the Stop and Start System is activated, the Stop and Start System will be turned off.

2. Was the sidestand operated?
When the sidestand is lowered, the Stop and Start System is deactivated.
3. Was the engine left stopped by the Stop and Start System for a long period of time?

If the engine is left stopped by the Stop and Start System for a long period of time, the battery could become discharged.

If the engine still does not restart after you checked the preceding conditions, have a Yamaha dealer check the vehicle as soon as possible.

9

9-35

Troubleshooting charts

Starting problems or poor engine performance

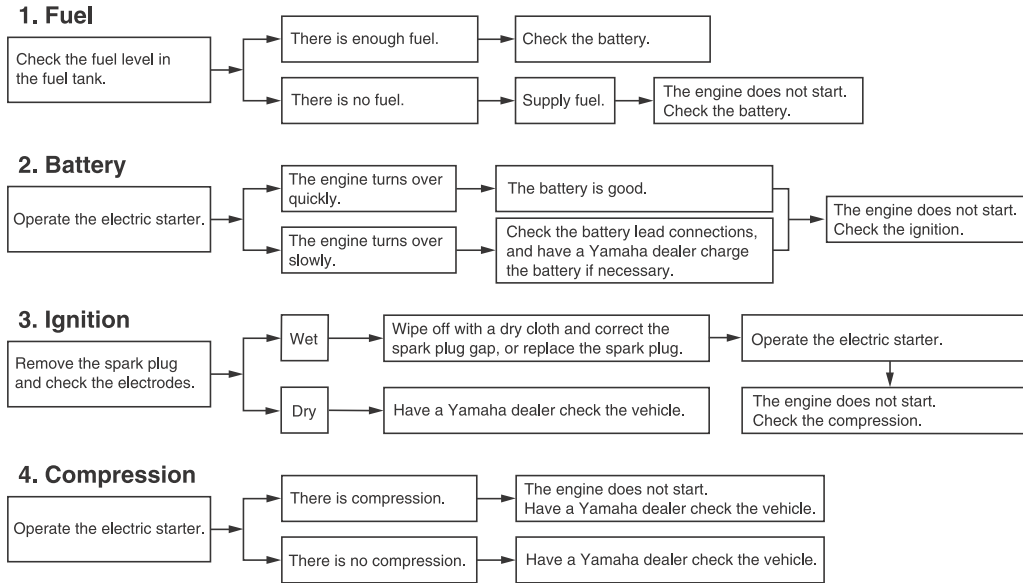

Periodic maintenance and adjustment

Engine overheating

⚠ WARNING

- Do not remove the radiator cap when the engine and radiator are hot. Scalding hot fluid and steam may be blown out under pressure, which could cause serious injury. Be sure to wait until the engine has cooled.
- Place a thick rag, like a towel, over the radiator cap, and then slowly rotate the cap counterclockwise to the detent to allow any residual pressure to escape. When the hissing sound has stopped, press down on the cap while turning it counterclockwise, and then remove the cap.

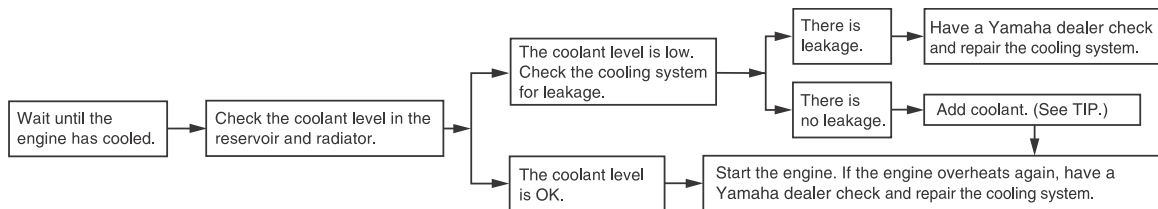

TIP

If coolant is not available, tap water can be temporarily used instead, provided that it is changed to the recommended coolant as soon as possible.

Periodic maintenance and adjustment

Emergency mode (GDR155-A) EAU76560

When the smart key is lost or damaged, or its battery has discharged, the vehicle can still be turned on and the engine started. You will need the smart key system identification number. (See page 4-3.)

To operate the vehicle in emergency mode

1. Stop the vehicle in a safe place and turn the main switch to "OFF".
2. Push the main switch knob for 5 seconds until the smart key system indicator light flashes once, then release it. Repeat two more times. The smart key system indicator light will come on for three seconds to indicate the transition to emergency mode.

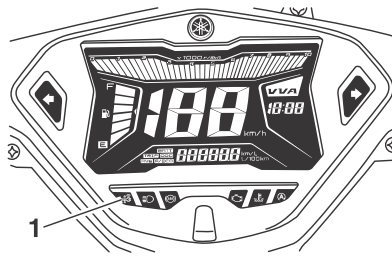

1. Smart key system indicator light "4b"
3. After the smart key system indicator light goes off, input the identification number as follows.

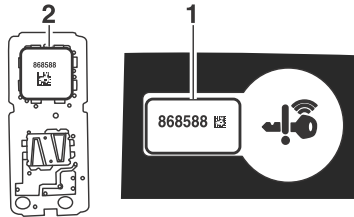

1. Identification number card
2. Identification number

4. Inputting the identification number is done by counting the number of flashes of the smart key system indicator light.

For example, if the identification number is 123456:

Push and hold the knob.

↓

The smart key system indicator light will start to flash.

↓



Release the knob after the smart key system indicator light flashes once.

↓

The first digit of the identification number has been set as "1".

↓

Push and hold the knob again.

↓

9

9-38

Periodic maintenance and adjustment



Release the knob after the smart key system indicator light flashes twice.

↓

The second digit has been set as "2".

↓

Repeat the above procedure until all digits of the identification number have been set. The smart key system indicator light will flash for 10 seconds if the correct identification number was entered.

TIP

When one of the following situations applies, emergency mode will be terminated and the smart key system indicator light will flash quickly for 3 seconds. In this case, start over again from step 2.

- When there are no knob operations for 10 seconds during the identification number input process.
- When the smart key system indicator light is allowed to flash nine or more times.
- The identification number is not entered correctly.

5. While the smart key system indicator light is on, push the knob once more to complete emergency mode access. The smart key indicator light will go off and then come back on for approximately 4 seconds.
6. While the smart key system indicator light is on, turn the main switch to "ON". The vehicle can now be operated normally.

9

9-39

Matte color caution

EAU37834

ECA15193

NOTICE

Some models are equipped with matte colored finished parts. Be sure to consult a Yamaha dealer for advice on what products to use before cleaning the vehicle. Using a brush, harsh chemical products or cleaning compounds when cleaning these parts will scratch or damage their surface. Wax also should not be applied to any matte colored finished parts.

Care

EAUJ0362

While the open design of a scooter reveals the attractiveness of the technology, it also makes it more vulnerable. Rust and corrosion can develop even if high-quality components are used. A rusty exhaust pipe may go unnoticed on a car, however, it detracts from the overall appearance of a scooter. Frequent and proper care does not only comply with the terms of the warranty, but it will also keep your scooter looking good, extend its life and optimize its performance.

Before cleaning

1. Cover the muffler outlet with a plastic bag after the engine has cooled down.
2. Make sure that all caps and covers as well as all electrical couplers and connectors, including the spark plug cap, are tightly installed.
3. Remove extremely stubborn dirt, like oil burnt onto the crankcase, with a degreasing agent and a brush, but never apply such prod-

10-1

ucts onto seals, gaskets and wheel axles. Always rinse the dirt and degreaser off with water.

Cleaning

ECA10784

NOTICE

- Avoid using strong acidic wheel cleaners, especially on spoked wheels. If such products are used on hard-to-remove dirt, do not leave the cleaner on the affected area any longer than instructed. Also, thoroughly rinse the area off with water, immediately dry it, and then apply a corrosion protection spray.
- Improper cleaning can damage plastic parts (such as cowlings, panels, windshields, headlight lenses, meter lenses, etc.) and the mufflers. Use only a soft, clean cloth or sponge with water to clean plastic. However, if the plastic parts cannot be thoroughly cleaned with water, diluted mild detergent with water may be used. Be sure to rinse

10

Scooter care and storage

off any detergent residue using plenty of water, as it is harmful to plastic parts.

- Do not use any harsh chemical products on plastic parts. Be sure to avoid using cloths or sponges which have been in contact with strong or abrasive cleaning products, solvent or thinner, fuel (gasoline), rust removers or inhibitors, brake fluid, antifreeze or electrolyte.
- Do not use high-pressure washers or steam-jet cleaners since they cause water seepage and deterioration in the following areas: seals (of wheel and swing-arm bearings, fork and brakes), electric components (couplers, connectors, instruments, switches and lights), breather hoses and vents.
- For scooters equipped with a windshield: Do not use strong cleaners or hard sponges as they will cause dulling or scratching. Some cleaning compounds for plastic may leave scratches on the wind-

shield. Test the product on a small hidden part of the windshield to make sure that it does not leave any marks. If the windshield is scratched, use a quality plastic polishing compound after washing.

After normal use

Remove dirt with warm water, a mild detergent, and a soft, clean sponge, and then rinse thoroughly with clean water. Use a toothbrush or bottlebrush for hard-to-reach areas. Stubborn dirt and insects will come off more easily if the area is covered with a wet cloth for a few minutes before cleaning.

After riding in the rain or near the sea

Since sea salt is extremely corrosive carry out the following steps after each ride in the rain or near the sea.

1. Clean the scooter with cold water and a mild detergent after the engine has cooled down. **NOTICE: Do not use warm water since it increases the corrosive action of the salt.** [ECA10792]

10-2

2. Apply a corrosion protection spray on all metal, including chrome- and nickel-plated, surfaces to prevent corrosion.

After cleaning

1. Dry the scooter with a chamois or an absorbing cloth.
2. Use a chrome polish to shine chrome, aluminum and stainless-steel parts, including the exhaust system. (Even the thermally induced discoloring of stainless-steel exhaust systems can be removed through polishing.)
3. To prevent corrosion, it is recommended to apply a corrosion protection spray on all metal, including chrome- and nickel-plated, surfaces.
4. Use spray oil as a universal cleaner to remove any remaining dirt.
5. Touch up minor paint damage caused by stones, etc.
6. Wax all painted surfaces.
7. Let the scooter dry completely before storing or covering it.

⚠ WARNING

EWA10943

Contaminants on the brakes or tires can cause loss of control.

- Make sure that there is no oil or wax on the brakes or tires. If necessary, clean the brake discs and brake linings with a regular brake disc cleaner or acetone, and wash the tires with warm water and a mild detergent.
- Before operating the scooter test its braking performance and cornering behavior.

NOTICE

ECAU0022

- Apply spray oil and wax sparingly and make sure to wipe off any excess.
- Never apply oil or wax to any rubber parts, plastic parts or headlight, taillight and meter lenses, but treat them with a suitable care product.
- Avoid using abrasive polishing compounds as they will wear away the paint.

TIP

- Consult a Yamaha dealer for advice on what products to use.
- Washing, rainy weather or humid climates can cause the headlight lens to fog. Turning the headlight on for a short period of time will help remove the moisture from the lens.

Storage

EAU36564

Short-term

Always store your scooter in a cool, dry place and, if necessary, protect it against dust with a porous cover. Be sure the engine and the exhaust system are cool before covering the scooter.

ECA10821

NOTICE

- Storing the scooter in a poorly ventilated room or covering it with a tarp, while it is still wet, will allow water and humidity to seep in and cause rust.
- To prevent corrosion, avoid damp cellars, stables (because of the presence of ammonia) and areas where strong chemicals are stored.

Long-term

Before storing your scooter for several months:

1. Follow all the instructions in the "Care" section of this chapter.

Scooter care and storage

2. Fill up the fuel tank and add fuel stabilizer (if available) to prevent the fuel tank from rusting and the fuel from deteriorating.
3. Perform the following steps to protect the cylinder, piston rings, etc. from corrosion.
 - a. Remove the spark plug cap and spark plug.
 - b. Pour a teaspoonful of engine oil into the spark plug bore.
 - c. Install the spark plug cap onto the spark plug, and then place the spark plug on the cylinder head so that the electrodes are grounded. (This will limit sparking during the next step.)
 - d. Turn the engine over several times with the starter. (This will coat the cylinder wall with oil.)
 - e. Remove the spark plug cap from the spark plug, and then install the spark plug and the spark plug cap. **WARNING! To prevent damage or injury from sparking, make sure to ground the spark plug electrodes while turning the engine over.**
4. Lubricate all control cables and the pivoting points of all levers and pedals as well as of the side-stand/centerstand.
5. Check and, if necessary, correct the tire air pressure, and then lift the scooter so that both of its wheels are off the ground. Alternatively, turn the wheels a little every month in order to prevent the tires from becoming degraded in one spot.
6. Cover the muffler outlet with a plastic bag to prevent moisture from entering it.
7. Remove the battery and fully charge it. Store it in a cool, dry place and charge it once a month. Do not store the battery in an excessively cold or warm place [less than 0 °C (30 °F) or more than 30 °C (90 °F)]. For more information on storing the battery, see page 9-27.

TIP

Make any necessary repairs before storing the scooter.

Dimensions:

Overall length:
1990 mm (78.3 in)
Overall width:
700 mm (27.6 in)
Overall height:
1125 mm (44.3 in)
Seat height:
790 mm (31.1 in)
Wheelbase:
1350 mm (53.1 in)
Ground clearance:
140 mm (5.51 in)
Minimum turning radius:
2.0 m (6.56 ft)

Weight:

Curb weight:
118 kg (260 lb) (GDR155-A)

Engine:

Combustion cycle:
4-stroke
Cooling system:
Liquid cooled
Valve train:
SOHC
Number of cylinders:
Single cylinder
Displacement:
155 cm³
Bore × stroke:
58.0 × 58.7 mm (2.28 × 2.31 in)
Compression ratio:
10.5 : 1

Starting system:
Electric starter
Lubrication system:
Wet sump

Engine oil:

Recommended brand:
YAMALUBE
SAE viscosity grades:
10W-40
Recommended engine oil grade:
API service SG type or higher, JASO
standard MA or MB
Engine oil quantity:
Oil change:
0.90 L (0.95 US qt, 0.79 Imp.qt)

Final transmission oil:

Type:
Motor oil SAE 10W-30 type SE or higher or
Gear oil SAE 85W GL-3
Quantity:
0.15 L (0.16 US qt, 0.13 Imp.qt)

Coolant quantity:

Coolant reservoir (up to the maximum level
mark):
0.13 L (0.14 US qt, 0.11 Imp.qt)
Radiator (including all routes):
0.46 L (0.49 US qt, 0.40 Imp.qt)

Air filter:

Air filter element:
Oil-coated paper element

Fuel:

Recommended fuel:
Regular unleaded gasoline only
11-1

Fuel tank capacity:
4.6 L (1.2 US gal, 1.0 Imp.gal)
Fuel reserve amount:
0.8 L (0.21 US gal, 0.18 Imp.gal)

Fuel injection:

Throttle body:
ID mark:
B631 00

Spark plug(s):

Manufacturer/model:
NGK/CPR8EA9
Manufacturer/model:
DENSO/U24EPR-9
Spark plug gap:
0.8–0.9 mm (0.031–0.035 in)

Clutch:

Clutch type:
Dry, centrifugal, shoe

Drivetrain:

Primary reduction ratio:
1.000
Final drive:
Gear
Secondary reduction ratio:
10.769 (56/16 × 40/13)
Transmission type:
V-belt automatic

Chassis:

Frame type:
Underbone
Caster angle:
26.5 °
Trail:
95 mm (3.7 in)

Specifications

Front tire:

Type:
Tubeless
Size:
110/80-14M/C 53P
Manufacturer/model:
IRC/SCT-005F

Rear tire:

Type:
Tubeless
Size:
140/70-14M/C 62P
Manufacturer/model:
IRC/SCT-005R

Loading:

Maximum load:
153 kg (337 lb) (GDR155-A)
(Total weight of rider, passenger, cargo
and accessories)

Tire air pressure (measured on cold tires):

1 person:
Front:
200 kPa (2.00 kgf/cm², 29 psi)
Rear:
225 kPa (2.25 kgf/cm², 33 psi)
2 persons:
Front:
200 kPa (2.00 kgf/cm², 29 psi)
Rear:
225 kPa (2.25 kgf/cm², 33 psi)

Front wheel:

Wheel type:
Cast wheel
Rim size:
14M/C x MT2.50

Rear wheel:

Wheel type:
Cast wheel
Rim size:
14M/C x MT3.50

Front brake:

Type:
Hydraulic single disc brake
Specified brake fluid:
YAMAHA GENUINE BRAKE FLUID : DOT
4-Plus (GDR155-A)

Rear brake:

Type:
Mechanical leading trailing drum brake

Front suspension:

Type:
Telescopic fork
Spring:
Coil spring
Shock absorber:
Hydraulic damper
Wheel travel:
100 mm (3.9 in)

Rear suspension:

Type:
Unit swing
Spring:
Coil spring 11-2

Shock absorber:
Hydraulic damper
Wheel travel:
86 mm (3.4 in)

Electrical system:

System voltage:
12 V
Ignition system:
TCI

Battery:

Model:
GTZ7V
Voltage, capacity:
12 V, 6.0 Ah (10 HR)

Bulb wattage:

Headlight:
LED
Brake/tail light:
LED
Front turn signal light:
10.0 W
Rear turn signal light:
10.0 W
Auxiliary light:
5.0 W
License plate light:
5.0 W
Meter lighting:
LED
High beam indicator light:
LED
Turn signal indicator light:
LED

- Coolant temperature warning light:
LED
- ABS warning light:
LED (GDR155-A)
- Stop and Start System indicator light:
LED (GDR155-A)
- Smart key system indicator light:
LED (GDR155-A)

Fuse(s):

- Main fuse:
30,0 A
- Terminal fuse 1:
2,0 A
- Headlight fuse:
7,5 A
- Signaling system fuse:
7,5 A
- Ignition fuse:
7,5 A
- Fuel injection system fuse:
7,5 A
- ABS control unit fuse:
2,0 A (GDR155-A)
- ABS motor fuse:
10,0 A (GDR155-A)
- ABS solenoid fuse:
7,5 A (GDR155-A)
- Backup fuse:
7,5 A
- Smart key system fuse:
2,0 A (GDR155-A)

Consumer information

Identification numbers

EAU26365

Record the vehicle identification number and the engine serial number in the spaces provided below for assistance when ordering spare parts from a Yamaha dealer or for reference in case the vehicle is stolen.

VEHICLE IDENTIFICATION NUMBER:

ENGINE SERIAL NUMBER:

Vehicle identification number

EAU62971

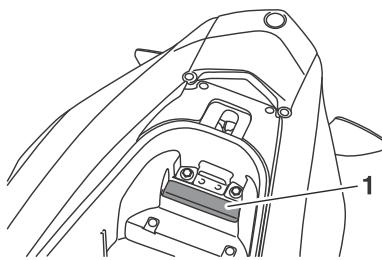

1. Vehicle identification number

The vehicle identification number is stamped into the frame under the passenger seat.

TIP

The vehicle identification number is used to identify your vehicle and may be used to register it with the licensing authority in your area.

Engine serial number

EAU26442

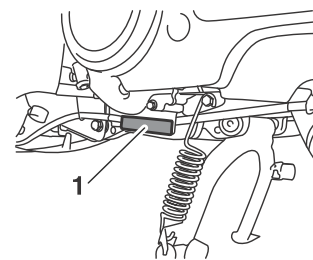

1. Engine serial number

The engine serial number is stamped into the crankcase.

- A**
- ABS (for ABS models) 6-11
 - ABS warning light (for ABS models) 6-4
 - Acceleration and deceleration 8-3
 - Activating the Stop and Start System 5-1
 - Air filter and V-belt case air filter elements 9-15
 - Auxiliary DC jack 6-20
 - Auxiliary light bulb, replacing 9-30
- B**
- Battery 9-27
 - Brake fluid, changing 9-23
 - Brake fluid level, checking 9-22
 - Brake lever 6-11
 - Brake lever, rear 6-11
 - Brake levers, lubricating 9-24
 - Brake pads and shoes, checking 9-21
 - Braking 8-3
- C**
- Cables, checking and lubricating 9-23
 - Care 10-1
 - Catalytic converter 6-14
 - Centerstand and sidestand, checking and lubricating 9-25
 - Coolant 9-13
 - Coolant temperature warning light 6-3
- D**
- Dimmer switch 6-10
- E**
- Emergency mode (GDR155-A) 9-38
 - Engine break-in 8-4
 - Engine oil and oil strainer 9-10
 - Engine serial number 12-1
 - Engine trouble warning light 6-4
- F**
- Final transmission oil 9-12
 - Front brake lever free play, checking... 9-20
 - Front fork, checking 9-25
 - Fuel 6-13
 - Fuel consumption, tips for reducing 8-3
 - Fuel tank cap 6-12
 - Fuel tank cap lid opening and closing 4-10
 - Fuel tank overflow hose 6-14
 - Fuses, replacing 9-28
- G**
- General note 8-6
- H**
- Handlebar switches 6-10
 - Headlight 9-30
 - Helmet holders 6-15
 - Helmets 2-6
 - High beam indicator light 6-3
 - Horn switch 6-10
- I**
- Identification numbers 12-1
 - Ignition circuit cut-off system 6-18
 - Indicator lights and warning lights 6-3
- K**
- Key, handling of smart and mechanical keys 4-3
 - Keyhole cover 6-2
- L**
- Labels, location 1-1
 - License plate light bulb, replacing 9-33
 - Light switch 6-10
- M**
- Main switch 4-7
- Main switch/steering lock 6-1
- Maintenance and lubrication, periodic ... 9-3
- Maintenance, emission control system 9-2
- Matte color, caution 10-1
- Multi-function meter unit 6-5
- O**
- Operating range of the smart key system 4-2
- P**
- Panels, removing and installing 9-7
 - Parking 8-4
 - Part locations 3-1
 - Precautions when using the Stop and Start System 5-3
- R**
- Rear brake lever free play, adjusting 9-20
- S**
- Safe-riding points 2-5
 - Safety information 2-1
 - Seat 6-15
 - Seat opening and closing 4-11
 - Sidestand 6-17
 - Smart key 4-5
 - Smart key battery, replacing 4-6
 - Smart key system 4-1
 - Smart key system indicator light 6-4
 - Smart key system, troubleshooting 9-34
 - Spark plug, checking 9-8
 - Specifications 11-1
 - Starting off 8-2
 - Starting the engine 8-1
 - Start switch 6-10
 - Steering, checking 9-26

Index

- Stop and Start System 5-1
 - Stop and Start System indicator light 6-5
 - Stop and Start System operation 5-1
 - Stop and Start System switch 6-10
 - Stop and Start System troubleshooting 9-34
 - Storage 10-3
 - Storage compartments 6-16
- T**
- Tail/brake light 9-31
 - Throttle grip and cable, checking and lubricating 9-24
 - Throttle grip free play, checking 9-17
 - Tires 9-18
 - Tool kit 9-1
 - Troubleshooting 9-33
 - Troubleshooting charts 9-36
 - Turn signal indicator lights 6-3
 - Turn signal light bulb (front), replacing 9-31
 - Turn signal light bulb (rear), replacing 9-32
 - Turn signal switch 6-10
- V**
- Valve clearance 9-17
 - V-belt, checking 9-23
 - Vehicle identification number 12-1
- W**
- Wheel bearings, checking 9-26
 - Wheels 9-19

YAMALUBE®



Pelincir Tulen Yamaha



PELINCIR MOTOSIKAL BERPRESTASI TINGGI