





! Read this manual carefully before operating this vehicle.

OWNER'S MANUAL

T 135 SE

55D-F8199-32

-  Baca buku panduan dengan teliti sebelum mengendalikan motosikal ini. Buku panduan ini diberi percuma dengan pembelian motosikal
-  Read this manual carefully before operating this vehicle. This manual should stay with this vehicle if it sold.
-  在使用这电单车以前，请充分使用这小手册。这手册须付与电单车一起。

MAKLUMAT PENTING PEMANDUAN

Sila dapatkan 2(Dua) kupon servis percuma dari pengedar/ penjual motosikal anda.

Get your 2 (Two) free service coupon from your motorcycle dealers

请向您的电单车代理商领取
2(两)张免费的维修卷

T135SE
BUKU PANDUAN PEMILIK
© Cetakan Januari 2016,
Oleh Syarikat Motor Yamaha Berhad
Hak cipta terpelihara.
Tidak boleh diterbitkan semula,
disimpan dalam cara yang boleh
dipergunakan lagi ataupun digunakan lagi,
jika tanpa izin terlebih dahulu dari
Syarikat Motor Yamaha Berhad,
Dicetak di Malaysia.

INTRODUCTION

Welcome to the Yamaha world of motorcycling!

As the owner of the **Yamaha T135 SE**, you are benefiting from Yamaha's vast experience and newest technology regarding the design and manufacture of high-quality products, which have earned Yamaha a reputation for dependability. Please take the time to read this manual thoroughly, so as to enjoy all advantages of your **Yamaha T135 SE**. The Owner's Manual does not only instruct you in how to operate, inspect and maintain your motorcycle, but also in how to safeguard yourself and others from trouble and injury.

In addition, the many tips given in this manual will help keep your motorcycle in the best possible condition. If you have any further questions, do not hesitate to contact your Yamaha dealer.

The Yamaha team wishes you many safe and pleasant rides. So, remember to put safety first!





Yamaha continually seeks advancements in product design and quality. Therefore, while this manual contains the most current product information available at the time of printing, there may be minor discrepancies between your motorcycle and this manual. If there is any question concerning this manual, please consult a Yamaha dealer.

WARNING

Please read this manual carefully and completely before operating this motorcycle.

IMPORTANT MANUAL INFORMATION

Particularly important information is distinguished in this manual by the following notations:

	This is the safety alert symbol. It is used to alert you to potential personal injury hazards. Obey all safety messages that follow this symbol to avoid possible injury or death.
	A WARNING indicates a hazardous situation which, if not avoid, could result in death or serious injury.
	A NOTICE indicates special precautions that must be taken to avoid damage to the vehicle or other property.
	A TIP provides key information to make procedures easier or clearer.

IMPORTANT MANUAL INFORMATION

T135SE
OWNER'S MANUAL
©2016 by Yamaha Motor CO., Ltd
1st edition, January 2016
All rights reserved.
Any reprinting or unauthorized use
without the written permission of
Yamaha Motor Co., Ltd
is expressly prohibited.
Printed in Malaysia

TABLE OF CONTENTS

LOCATION OF IMPORTANT LABELS.....	1-1	OPERATION AND IMPORTANT RIDING POINTS.....	5-1	Checking the brake lever free play	6-22
SAFETY INFORMATION	1-2	Starting and warming up a cold engine	5-1	Adjusting the brake pedal free play	6-22
DESCRIPTION	2-1	Starting a warm engine	5-2	Adjusting the rear brake light switch	6-23
Left view	2-1	Shifting	5-3	Checking the front brake pads and rear brake shoes	6-23
Right view	2-2	Tips for reducing fuel consumption	5-3	Checking the front brake fluid level	6-24
Controls and instruments.....	2-3	Engine break-in	5-4	Changing the brake fluid	6-25
INSTRUMENT AND CONTROL FUNCTIONS	3-1	Parking	5-5	Drive chain slack	6-25
Main switch/steering lock	3-1	General note	5-6	Cleaning and lubricating the drive chain	6-27
Keyhole cover	3-2	PERIODIC MAINTENANCE AND MINOR REPAIR	6-1	Checking and lubricating the cables	6-28
Indicator and warning lights	3-3	Owner's tool kit	6-1	Checking and lubricating the throttle grip and cable	6-28
Speedometer unit	3-4	Periodic maintenance and lubrication chart	6-2	Lubricating the brake lever	6-29
Fuel gauge	3-4	Removing and installing the cowlings and panel	6-5	Lubricating the brake pedal	6-29
Handlebar switches	3-4	Checking the spark plug	6-7	Checking and lubricating the centerstand and sidestand	6-29
Shift pedal	3-5	Engine oil and oil filter element	6-10	Lubricating the swingarm pivots	6-30
Brake lever	3-6	Coolant	6-13	Checking the front fork	6-30
Brake pedal	3-6	Cleaning the air filter element	6-15	Checking the steering	6-31
Fuel tank cap	3-6	Adjusting the carburetor	6-17	Checking the wheel bearings	6-31
Fuel	3-7	Adjusting the engine idling speed	6-17	Battery	6-32
Catalytic converter	3-8	Adjusting the throttle cable free play	6-18	Replacing the fuse	6-33
Starter (choke) lever	3-8	Valve clearance	6-19	Replacing a headlight bulb	6-34
Kickstarter	3-9	Tires	6-19		
Seat	3-9	Wheel	6-21		
Helmet holders	3-9				
Storage compartment	3-10				
Sidestand	3-10				
PRE-OPERATION CHECKS.....	4-1				
Pre-operation check list	4-2				

TABLE OF CONTENTS

Replacing a front turn signal light bulb or an auxiliary light bulb	6-35
Rear turn signal light and tail/brake light	6-35
Front wheel	6-36
Rear wheel	6-37
Troubleshooting	6-39
Troubleshooting charts	6-40
MOTORCYCLE CARE AND STORAGE	7-1
Care	7-1
Storage	7-3
SPECIFICATIONS	8-1
CONSUMER INFORMATION.....	9-1
Identification numbers	9-1

LOCATION OF IMPORTANT LABELS

1

Read and understand all of the labels on your vehicle. They contain important information for safe and proper operation of your vehicle. Never remove any labels from your vehicle. If a label becomes difficult to read or comes off, a replacement label is available from your Yamaha dealer.

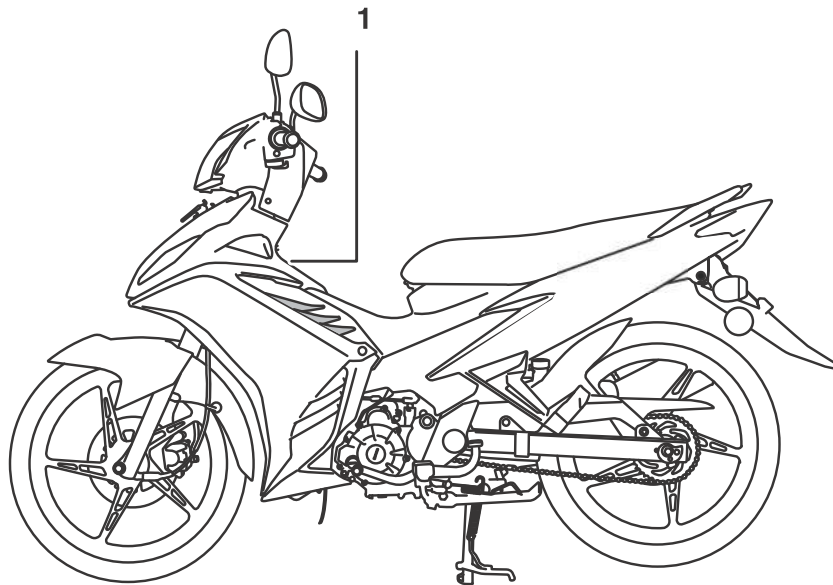

1-1

SAFETY INFORMATION

Be a Responsible Owner

As the vehicle's owner, you are responsible for the safe and proper operation of your motorcycle.

Motorcycles are single-track vehicles. Their safe use and operation are dependent upon the use of proper riding techniques as well as the expertise of the operator. Every operator should know the following requirements before riding this motorcycle.

He or she should:

- Obtain thorough instructions from a competent source on all aspects of motorcycle operation.
- Observe the warnings and maintenance requirements in this Owner's Manual.
- Obtain qualified training in safe and proper riding techniques.
- Obtain professional technical service as indicated in this Owner's Manual and/or when made necessary by mechanical conditions.

Safe Riding

Perform the pre-operation checks each time you use the vehicle to make sure it is in safe operating condition. Failure to inspect or maintain the vehicle properly increases the possibility of an accident or equipment damage. See page 5-1 for a list of pre-operation checks.

- This motorcycle is designed to carry the operator and a passenger.
- The failure of motorists to detect and recognize motorcycles in traffic is the predominating cause of automobile/motorcycle accidents. Many accidents have been caused by an automobile driver who did not see the motorcycle. Making yourself conspicuous appears to be very effective in reducing the chance of this type of accident.

Therefore:

- Wear a brightly colored jacket.
- Use extra caution when you are approaching and passing through intersections, since in-

tersections are the most likely places for motorcycle accidents to occur.

- Ride where other motorists can see you. Avoid riding in another motorist's blind spot.
- Many accidents involve inexperienced operators. In fact, many operators who have been involved in accidents do not even have a current motorcycle license.
- Make sure that you are qualified and that you only lend your motorcycle to other qualified operators
- Know your skills and limits. Staying within your limits may help you to avoid an accident.
- We recommend that you practice riding your motorcycle where there is no traffic until you have become thoroughly familiar with the motorcycle and all of its controls.
- Many accidents have been caused by error of the motorcycle operator. A typical error made by

SAFETY INFORMATION

the operator is veering wide on a turn due to excessive speed or undercornering (insufficient lean angle for the speed).

- Always obey the speed limit and never travel faster than warranted by road and traffic conditions.
- Always signal before turning or changing lanes. Make sure that other motorists can see you.
- The posture of the operator and passenger is important for proper control.
 - The operator should keep both hands on the handlebar and both feet on the operator footrests during operation to maintain control of the motorcycle.
 - The passenger should always hold onto the operator, the seat strap or grab bar, if equipped, with both hands and keep both feet on the passenger footrests. Never carry a passenger unless he or she can firmly place both feet on the passenger footrests.

- Never ride under the influence of alcohol or other drugs.

Protective apparel

The majority of fatalities from motorcycle accidents are the result of head injuries. The use of a safety helmet is the single most critical factor in the prevention or reduction of head injuries.

- Always wear an approved helmet.
- Wear a face shield or goggles. Wind in your unprotected eyes could contribute to an impairment of vision that could delay seeing a hazard.
- The use of a jacket, heavy boots, trousers, gloves, etc., is effective in preventing or reducing abrasions or lacerations.
- Never wear loose-fitting clothes, otherwise they could catch on the control levers, footrests, or wheels and cause injury or an accident.
- Always wear protective clothing that covers your legs, ankles, and feet. The engine or exhaust sys-

tem become very hot during or after operation and can cause burns.

- A passenger should also observe the above precautions.

Avoid Carbon Monoxide Poisoning

All engine exhaust contains carbon monoxide, a deadly gas. Breathing carbon monoxide can cause headaches, dizziness, drowsiness, nausea, confusion, and eventually death.

Carbon Monoxide is a colorless, odorless, tasteless gas which may be present even if you do not see or smell any engine exhaust. Deadly levels of carbon monoxide can collect rapidly and you can quickly be overcome and unable to save yourself. Also, deadly levels of carbon monoxide can linger for hours or days in enclosed or poorly ventilated areas. If you experience any symptoms of carbon monoxide poisoning, leave the area immediately, get fresh air, and SEEK MEDICAL TREATMENT.

1-3

SAFETY INFORMATION

- Do not run engine indoors. Even if you try to ventilate engine exhaust with fans or open windows and doors, carbon monoxide can rapidly reach dangerous levels.
- Do not run engine in poorly ventilated or partially enclosed areas such as barns, garages, or carports.
- Do not run engine outdoors where engine exhaust can be drawn into a building through openings such as windows and doors.

Loading

Adding accessories or cargo to your motorcycle can adversely affect stability and handling if the weight distribution of the motorcycle is changed. To avoid the possibility of an accident, use extreme caution when adding cargo or accessories to your motorcycle. Use extra care when riding a motorcycle that has added cargo or accessories. Here, along with the information about accessories below, are some general

guidelines to follow if loading cargo to your motorcycle:

The total weight of the operator, passenger, accessories and cargo must not exceed the maximum load limit. Operation of an overloaded vehicle could cause an accident.

Maximum load:
150 kg (331 lb)

When loading within this weight limit, keep the following in mind:

- Cargo and accessory weight should be kept as low and close to the motorcycle as possible. Securely pack your heaviest items as close to the center of the vehicle as possible and make sure to distribute the weight as evenly as possible on both sides of the motorcycle to minimize imbalance or instability.
- Shifting weights can create a sudden imbalance. Make sure that accessories and cargo are securely

attached to the motorcycle before riding. Check accessory mounts and cargo restraints frequently.

- Properly adjust the suspension for your load, and check the condition and pressure of your tires.
- Never attach any large or heavy items to the handlebar, front fork, or front fender. These items, including such cargo as sleeping bags, duffel bags, or tents, can create unstable handling or a slow steering response.
- **This vehicle is not designed to pull a trailer or to be attached to a sidecar.**

Genuine Yamaha Accessories

Choosing accessories for your vehicle is an important decision. Genuine Yamaha accessories, which are available only from a Yamaha dealer, have been designed, tested, and approved by Yamaha for use on your vehicle.

1-4

SAFETY INFORMATION

1

Many companies with no connection to Yamaha manufacture parts and accessories or offer other modifications for Yamaha vehicles. Yamaha is not in a position to test the products that these aftermarket companies produce. Therefore, Yamaha can neither endorse nor recommend the use of accessories not sold by Yamaha or modifications not specifically recommended by Yamaha, even if sold and installed by a Yamaha dealer.

Aftermarket Parts, Accessories, and Modifications

While you may find aftermarket products similar in design and quality to genuine Yamaha accessories, recognize that some aftermarket accessories or modifications are not suitable because of potential safety hazards to you or others. Installing aftermarket products or having other modifications performed to your vehicle that change any of the vehicle's design or operation

characteristics can put you and others at greater risk of serious injury or death. You are responsible for injuries related to changes in the vehicle.

Keep the following guidelines in mind, as well as those provided under "Loading" when mounting accessories.

- Never install accessories or carry cargo that would impair the performance of your motorcycle. Carefully inspect the accessory before using it to make sure that it does not in any way reduce ground clearance or cornering clearance, limit suspension travel, steering travel or control operation, or obscure lights or reflectors.
- Accessories fitted to the handlebar or the front fork area can create instability due to improper weight distribution or aerodynamic changes. If accessories are added to the handlebar or front fork area, they must be as lightweight as possible and should be kept to a minimum.

1-5

- Bulky or large accessories may seriously affect the stability of the motorcycle due to aerodynamic effects. Wind may attempt to lift the motorcycle, or the motorcycle may become unstable in cross winds. These accessories may also cause instability when passing or being passed by large vehicles.
- Certain accessories can displace the operator from his or her normal riding position. This improper position limits the freedom of movement of the operator and may limit control ability, therefore, such accessories are not recommended.
- Use caution when adding electrical accessories. If electrical accessories exceed the capacity of the motorcycle's electrical system, an electric failure could result, which could cause a dangerous loss of lights or engine power.

DESCRIPTION

Left view

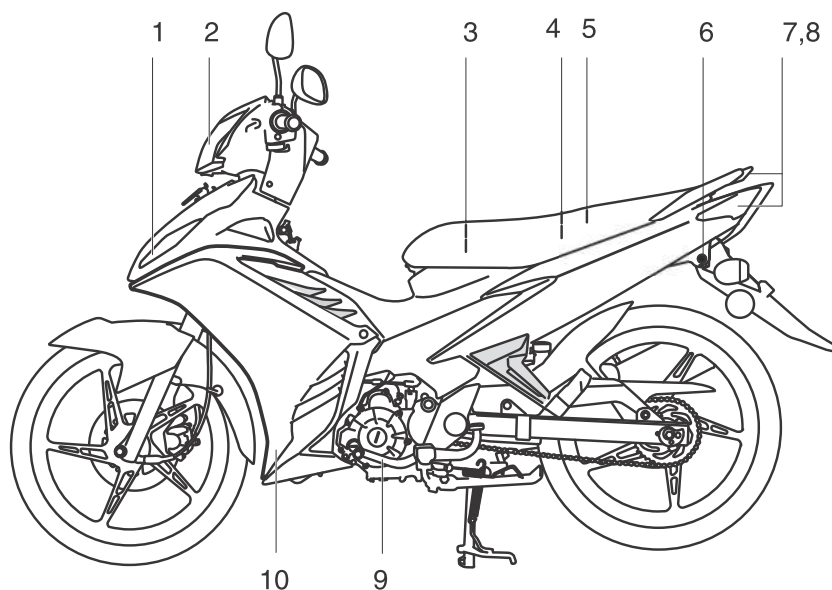

1. Front turn signal/auxiliary lights (page 6-35)
2. Headlight (page 6-34)
3. Battery (page 6-32)
4. Storage compartment (page 3-10)
5. Owner's tool kit (page 6-1)

6. Seat lock (page 3-9)
7. Tail/brake light (page 6-35)
8. Rear turn signal lights (page 6-35)
9. Shift pedal (page 3-6)
10. Coolant reservoir (page 6-14)

DESCRIPTION

Right view

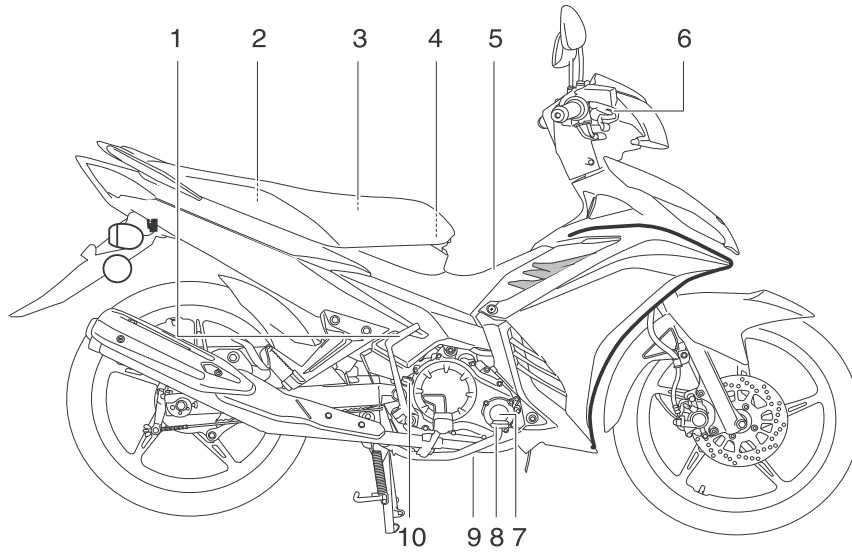

1. Kickstarter (page 3-9)
2. Fuel tank cap (page 3-6)
3. Fuse (page 6-33)
4. Helmet holder (page 3-9)
5. Air filter element (page 6-15)

6. Front brake fluid reservoir (page 6-24)
7. Engine oil filter element (page 6-11)
8. Brake pedal (page 3-6)
9. Engine oil drain bolt (page 6-11)
10. Engine oil filler cap (page 6-11)

2-2

DESCRIPTION

Controls and instruments

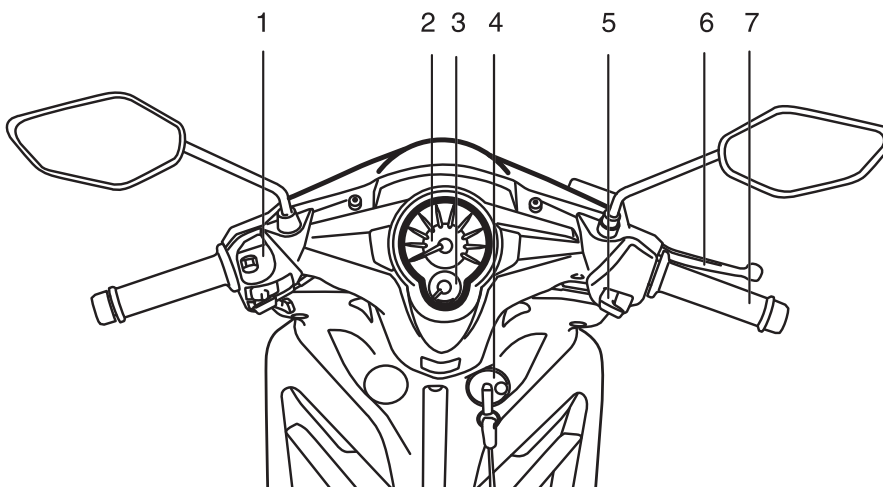

1. Left handlebar switches (page 3-4)
2. Speedometer unit (page 3-4)
3. Fuel gauge (page 3-4)
4. Main switch/steering lock (page 3-1)

5. Right handlebar switch (page 3-5)
6. Brake lever (page 3-6)
7. Throttle grip (page 6-18)

2-3

INSTRUMENT AND CONTROL FUNCTIONS

Main switch/steering lock

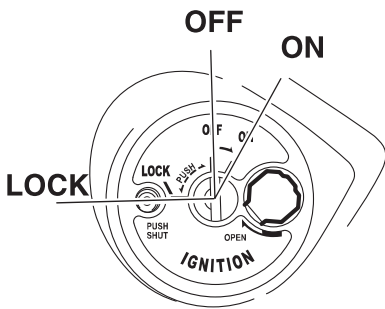

The main switch/steering lock controls the ignition and lighting systems, and is used to lock the steering. The various positions are described below.

ON

All electrical systems are supplied with power, and the meter lighting comes on, and the engine can be started. The key cannot be removed.

OFF

All electrical systems are off. The key can be removed.

LOCK

The steering is locked, and all electrical systems are off. The key can be removed.

To lock the steering

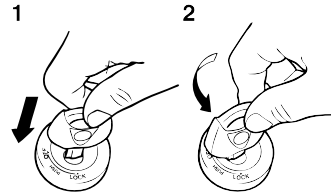

1. Push.
2. Turn.

1. Turn the handlebars all the way to the left.
2. Push the key in from the "OFF" position, and then turn it to "LOCK"
3. Remove the key.

To unlock the steering

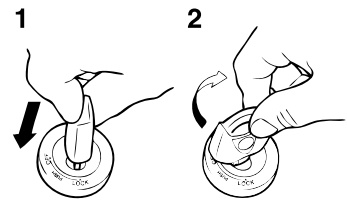

Insert the key and turn it to "OFF".

⚠ WARNING

Never turn the key to "OFF" or "LOCK" while the vehicle is moving, otherwise the electrical systems will be switched off, which may result in loss of control or an accident. Make sure that the vehicle is stopped before turning the key to "OFF" or "LOCK".

INSTRUMENT AND CONTROL FUNCTIONS

Keyhole cover

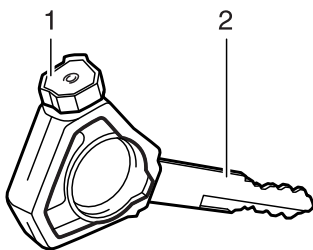

1. Shutter key
For open and close keyhole cover
2. Ignition switch
For starting the engine

To open the keyhole cover

Insert the key head into the key hole cover receptacle as shown, and then turn the key to the right to open the cover.

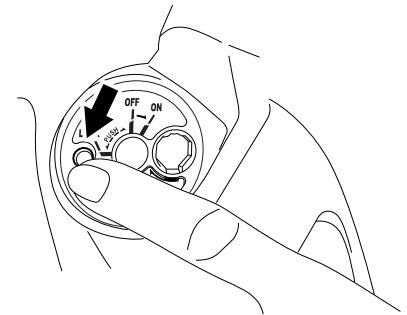
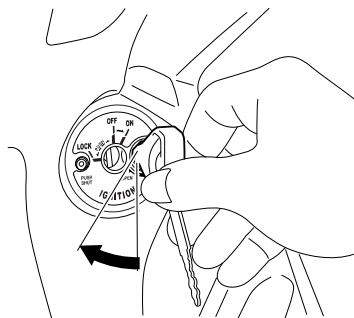

1. push shut bottom

To close the keyhole cover

Push the push shut bottom after remove the key.

INSTRUMENT AND CONTROL FUNCTIONS

Indicator and warning lights

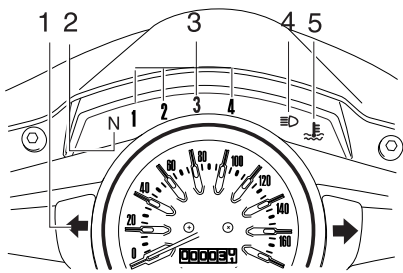

1. Turn signal indicator light "↔"
2. Neutral indicator light "N"
3. Gear position indicator light "1" "2" "3" "4"
4. High beam indicator light "≡"
5. Coolant temperature warning light "⊡"

Turn signal indicator light "↔"

This indicator light flashes when the turn signal switch is pushed to the left or right.

Neutral indicator light "N"

This indicator light comes on when the transmission is in the neutral position.

Gear position indicator lights "1" "2" "3", and "4"

The respective indicator light comes on when the transmission is in the 1st, 2nd, 3rd or 4th gear position.

High beam indicator light "≡"

This indicator light comes on when the high beam of the headlight is switched on.

Coolant temperature warning light "⊡"

This warning light comes on when the engine overheats. When this occurs, stop the engine immediately and allow the engine to cool.

This warning light also has a self-diagnosis device function for various electrical circuits.

- When the main switch is turned to "ON" and the engine is not running, the warning light will flash if an electrical circuit is defective. If this occurs, have a Yamaha dealer check the vehicle.

- When the engine is running, the warning light will come on if the engine overheats or if an electrical circuit is defective.

To determine which of the above is occurring, stop the vehicle when it is safe to do so, then turn the main switch to "OFF", and then back to "ON".

If the warning light stays on, this indicates the engine is overheating. Keep the engine turned off and allow it to cool.

NOTICE

Do not operate the engine if it is overheated.

If the warning light flashes, this indicates there is a defective electrical circuit. Have a Yamaha dealer check the vehicle.

The electrical circuit of the warning light can be checked by turning the key to "ON".

If the warning light does not come on for a few seconds, then go off, have a Yamaha dealer check the electrical circuit.

INSTRUMENT AND CONTROL FUNCTIONS

Speedometer unit

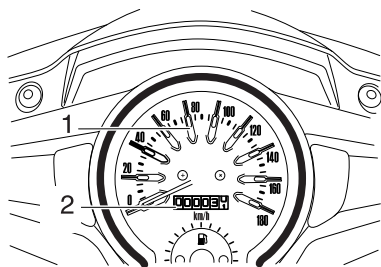

1. Speedometer
2. Odometer

The speedometer unit is equipped with a speedometer and an odometer. The speedometer shows riding speed. The odometer shows the total distance traveled.

Fuel gauge

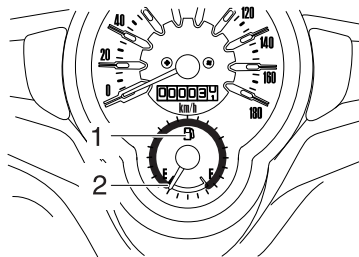

1. Fuel gauge
2. Red zone

The fuel gauge indicates the amount of fuel in the fuel tank. The needle moves towards "E" (Empty) as the fuel level decreases. When the needle reaches the red zone, approximately 1.0 L (0.26 US gal) (0.22 Imp.gal) remain in the fuel tank. If this occurs, refuel as soon as possible.

TIP

- Do not allow the fuel tank to empty itself completely.
- The main switch must be turned to "ON" for the fuel gauge to display an accurate fuel level reading.

Handlebar switches

Left

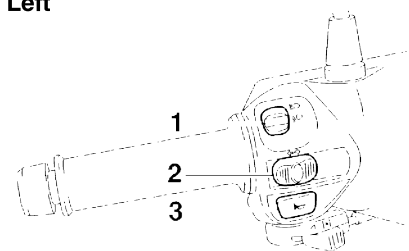

1. Dimmer switch "≡/≡"
2. Turn signal switch "↔/↔"
3. Horn switch "📢"

Dimmer switch "≡/≡"

Set this switch to "≡" for the high beam and to "≡" for the low beam.

INSTRUMENT AND CONTROL FUNCTIONS

Turn signal switch “↔/↔”

To signal a right-hand turn, push this switch to “↔”. To signal a left-hand turn, push this switch to “↔”. When released, the switch returns to the center position. To cancel the turn signal lights, push the switch in after it has returned to the center position.

Horn switch “🔊”

Press this switch to sound the horn.

Right

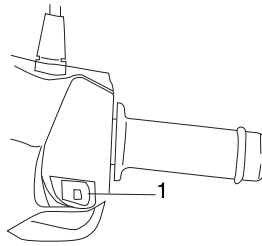

1. Start switch “🔌”

Start switch “🔌”

Push this switch to crank the engine with the starter.

NOTICE

See page 5-1 for starting instructions prior to starting the engine.

Shift pedal

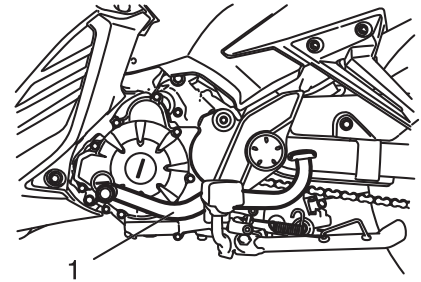

1. Shift pedal

The shift pedal is located on the left side of the engine. This motorcycle is equipped with a constant-mesh 4 speed transmission.

TIP

Use your toes to shift up and your heel to shift down.

INSTRUMENT AND CONTROL FUNCTIONS

Brake lever

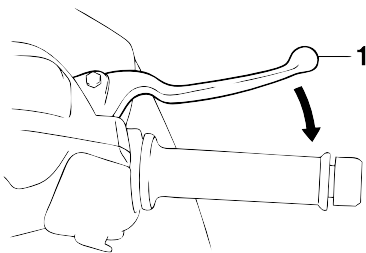

1. Brake lever

The brake lever is located at the right handlebar grip. To apply the front brake, pull the lever toward the handlebar grip.

Brake pedal

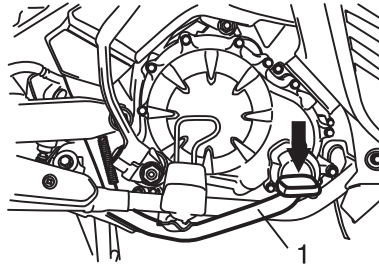

1. Brake pedal

The brake pedal is on the right side of the motorcycle. To apply the rear brake, press down on the brake pedal.

Fuel tank cap

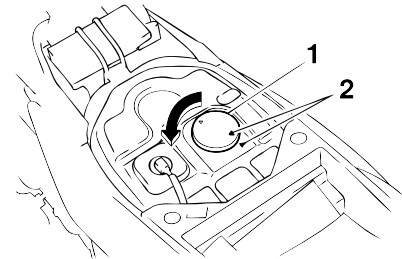

1. Fuel tank cap
2. “△” mark

To remove the fuel tank cap

1. Open the seat. (See page 3-9.)
2. Turn the fuel tank cap counter-clockwise and pull it off.

To install the fuel tank cap

1. Insert the fuel tank cap into the tank opening and turn it clockwise until the “△” marks on the cap and tank are aligned.
2. Close the seat.

⚠ WARNING

Make sure that the fuel tank cap is properly closed before riding.

INSTRUMENT AND CONTROL FUNCTIONS

Fuel

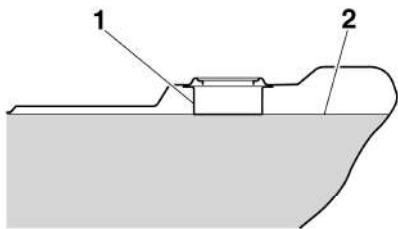

1. Fuel tank filler tube
2. Fuel level

Make sure there is sufficient gasoline in the tank.

WARNING

Gasoline and gasoline vapors are extremely flammable. To avoid fires and explosions and to reduce the risk of injury when refueling, follow these instructions.

1. Before refueling, turn off the engine and be sure that no one is sitting on the vehicle. Never refuel while smoking, or while in the vicinity of sparks, open flames, or other sources of ignition such as the pilot lights of water heaters and clothes dryers.
2. Do not overfill the fuel tank. Stop filling when the fuel reaches the bottom of the filler tube. Because fuel expands when it heats up, heat from the engine or the sun can cause fuel to spill out of the fuel tank.
3. Wipe up any spilled fuel immediately. **NOTICE: Immediately wipe off spilled fuel with a clean, dry, soft cloth, since fuel may deteriorate painted surfaces or plastic parts.**
4. Be sure to securely close the fuel tank cap.

WARNING

Gasoline is poisonous and can cause injury or death. Handle gasoline with care. Never siphon gasoline by mouth. If you should swallow some gasoline or inhale a lot of gasoline vapor, or get some gasoline in your eyes, see your doctor immediately. If gasoline spills on your skin, wash with soap and water. If gasoline spills on your clothing, change your clothes.

3-7

INSTRUMENT AND CONTROL FUNCTIONS

Recommended fuel:

Regular unleaded gasoline only

Fuel tank capacity:

4.0 L (1.06 US gal) (0.88 Imp.gal)

NOTICE

Use only unleaded gasoline. The use of leaded gasoline will cause severe damage to internal engine parts, such as the valves and piston rings, as well as to the exhaust system.

Catalytic converter

This model is equipped with a catalytic converter in the exhaust system.

WARNING

The exhaust system is hot after operation. Make sure that the exhaust system has cooled down before doing any maintenance work.

NOTICE

The following precautions must be observed to prevent a fire hazard or other damages.

- Use only unleaded gasoline. The use of leaded gasoline will cause unreparable damage to the catalytic converter.
- Never park the vehicle near possible fire hazards such as grass or other materials that easily burn.
- Do not allow the engine to idle too long.

Starter (choke) lever “N”

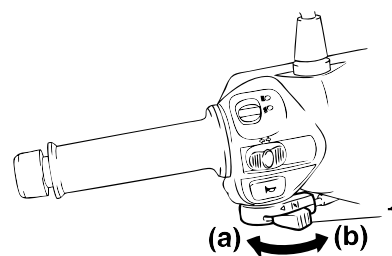

1. Starter (choke) lever “N”

Starting a cold engine requires a richer air-fuel mixture, which is supplied by the starter (choke).

Move the lever in direction (a) to turn on the starter (choke).

Move the lever in direction (b) to turn off the starter (choke).

3-8

INSTRUMENT AND CONTROL FUNCTIONS

Kickstarter

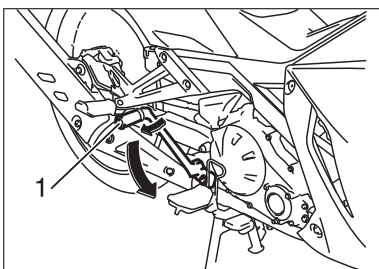

1. Kickstarter

If the engine fails to start by pushing the start switch, try to start it by using the kickstarter. To start the engine, fold out the kickstarter lever, move it down lightly with your foot until the gears engage, and then push it down smoothly but forcefully.

Seat

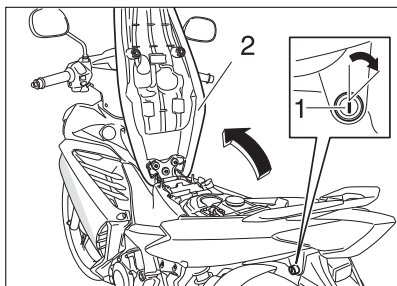

1. Seat lock
2. Seat

To open the seat

1. Insert the key in the lock, and then turn it as shown.
2. Fold the seat up.

To close the seat

1. Fold the seat down, and then push it down to lock it in place.
2. Remove the key.

TIP _____
Make sure that the seat is properly secured before riding.

Helmet holders

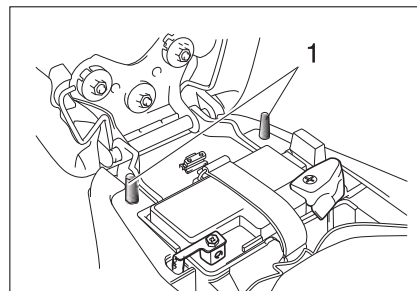

1. Helmet holder

The helmet holders are located under the seat.

To secure a helmet to a helmet holder

1. Open the seat. (See page 3-9.)
2. Attach a helmet to a helmet holder, and then securely close the seat.

WARNING! Never ride with a helmet attached to the helmet holder, since the helmet may hit objects, causing loss of control and possibly an accident.

3-9

INSTRUMENT AND CONTROL FUNCTIONS

To release a helmet from a helmet holder

Open the seat, remove the helmet from the helmet holder, and then close the seat.

Storage compartment

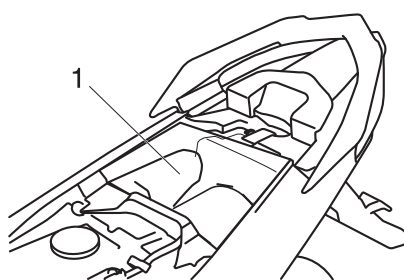

1. Storage compartment

The storage compartment is located under the seat. (See page 3-9.)

When storing the owner's manual or other documents in the storage compartment, be sure to wrap them in a plastic bag so that they will not get wet. When washing the vehicle, be careful not to let any water enter the storage compartment.

Sidestand

The sidestand is located on the left side of the frame. Raise the sidestand or lower it with your foot while holding the vehicle upright.

! WARNING

The vehicle must not be ridden with the sidestand down, or if the sidestand cannot be properly moved up (or does not stay up), otherwise the sidestand could contact the ground and distract the operator, resulting in a possible loss of control.

3

3-10

PRE-OPERATION CHECKS

Inspect your vehicle each time you use it to make sure the vehicle is in safe operating condition. Always follow the inspection and maintenance procedures and schedules described in the Owner's Manual.

⚠ WARNING

Failure to inspect or maintain the vehicle properly increases the possibility of an accident or equipment damage. Do not operate the vehicle if you find any problem. If a problem cannot be corrected by the procedures provided in this manual, have the vehicle inspected by a Yamaha dealer.

Before using this vehicles, check the following points:

PRE-OPERATION CHECKS

Pre-operation check list

ITEM	CHECKS	PAGE
Fuel	<ul style="list-style-type: none"> • Check fuel level in fuel tank. • Refuel if necessary. • Check fuel line for leakage. 	3-7
Engine oil	<ul style="list-style-type: none"> • Check oil level in engine. • If necessary, add recommended oil to specified level. • Check vehicle for oil leakage. 	6-10
Coolant	<ul style="list-style-type: none"> • Check coolant level in reservoir. • If necessary, add recommended coolant to specified level. • Check cooling system for leakage. 	6-13
Front brake	<ul style="list-style-type: none"> • Check operation. • If soft or spongy, have Yamaha dealer bleed hydraulic system. • Check brake pads for wear. • Replace if necessary. • Check fluid level in reservoir. • If necessary, add recommended brake fluid to specified level. • Check hydraulic system for leakage. 	6-22, 6-24
Rear brake	<ul style="list-style-type: none"> • Check operation. • Check pedal free play. • Adjust if necessary. 	6-22
Throttle grip	<ul style="list-style-type: none"> • Make sure that operation is smooth. • Lubricate if necessary. • Check free play. • Adjust if necessary. 	6-18
Control cables	<ul style="list-style-type: none"> • Make sure that operation is smooth. • Lubricate if necessary. 	6-28
Drive chain	<ul style="list-style-type: none"> • Check chain slack • Adjust if necessary. • Check chain condition. • Lubricate if necessary 	6-22, 6-25

PRE-OPERATION CHECKS

ITEM	CHECKS	PAGE
Wheels and tires	<ul style="list-style-type: none"> • Check for damage. • Check tire condition and tread depth. • Check air pressure. • Correct if necessary. 	6-19, 6-21
Brake pedal	<ul style="list-style-type: none"> • Make sure that operation is smooth. • Lubricate pedal pivoting point if necessary. 	6-29
Brake lever	<ul style="list-style-type: none"> • Make sure that operation is smooth. • Lubricate lever pivoting point if necessary. 	6-22
Centerstand, sidestand	<ul style="list-style-type: none"> • Make sure that operation is smooth. • Lubricate pivots if necessary. 	6-29
Chassis fasteners	<ul style="list-style-type: none"> • Make sure that all nuts, bolts and screws are properly tightened. • Tighten if necessary. 	—
Instruments, lights, signals and switches	<ul style="list-style-type: none"> • Check operation. • Correct if necessary. 	—
Battery	<ul style="list-style-type: none"> • Check fluid level. • Fill with distilled water if necessary. 	6-32

4-3

OPERATION AND IMPORTANT RIDING POINTS

Read the Owner's Manual carefully to become familiar with all controls. If there is a control or function you do not understand, ask your Yamaha dealer.

WARNING

- **Become thoroughly familiar with all operating controls and their functions before riding. Consult a Yamaha dealer regarding any control or function that you do not thoroughly understand.**
- **Never start the engine or operate it in a closed area for any length of time. Exhaust fumes are poisonous, and inhaling them can cause loss of consciousness and death within a short time. Always make sure that there is adequate ventilation.**

- **Before starting out, make sure that the sidestand is up. If the sidestand is not raised completely, it could contact the ground and distract the operator, resulting in a possible loss of control.**

NOTICE

Do not ride through deep water (including puddles), otherwise the engine may be damaged.

Starting and warming up a cold engine

1. Turn the key to "ON".
2. Shift the transmission into the neutral position.

TIP

When the transmission is in the neutral position, the neutral indicator light should be on, otherwise have a Yamaha dealer check the electrical circuit.

3. Place the vehicle on the centerstand.

WARNING

Before starting the engine, make sure the transmission is in neutral and that the vehicle is placed on the centerstand.

4. Turn the starter (choke) on and completely close the throttle. (See page 3-8.)
5. Start the engine by pushing the start switch or by pushing the kick-starter lever down.

5-1

OPERATION AND IMPORTANT RIDING POINTS

TIP

If the engine fails to start by pushing the start switch, release the switch, wait a few seconds, and then try again. Each starting attempt should be as short as possible to preserve the battery. Do not crank the engine more than 10 seconds on any one attempt. If the engine does not start with the starter motor, try using the kickstarter.

NOTICE

The coolant temperature warning light should come on when the key is turned to "ON", and then go off after a few seconds. If the coolant temperature warning light comes on after starting, immediately stop the engine, and have a Yamaha dealer check the electrical circuit.

6. After starting the engine, move the starter (choke) back halfway.

NOTICE

For maximum engine life, always warm the engine up before starting off. Never accelerate hard when the engine is cold!

7. When the engine is warm, turn the starter (choke) off.

TIP

The engine is warm when it responds normally to the throttle with the starter (choke) turned off.

Starting a warm engine

Follow the same procedure as for starting a cold engine with the exception that the starter (choke) is not required when the engine is warm.

5-2

OPERATION AND IMPORTANT RIDING POINTS

Shifting

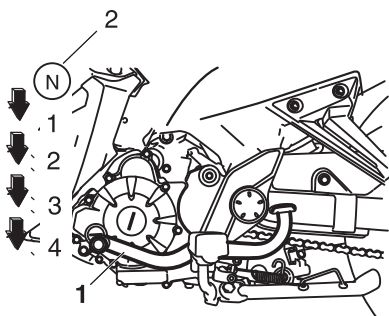

1. Shift pedal
2. Neutral position

Shifting gears lets you control the amount of engine power available for starting off, accelerating, climbing hills, etc.

The gear positions are shown in the illustration.

TIP

To shift the transmission into the neutral position, press the shift pedal down repeatedly until it reaches the end of its travel, and then slightly raise it.

NOTICE

- Make sure that the transmission is completely shifted into gear.
- Be sure to fully close the throttle grip when shifting.
- Make sure the neutral indicator light comes on when the transmission is in the neutral position.

Tips for reducing fuel consumption

Fuel consumption depends largely on your riding style. Consider the following tips to reduce fuel consumption:

- Turn the starter (choke) off as soon as possible.
- Shift up swiftly, and avoid high engine speeds during acceleration.
- Do not rev the engine while shifting down, and avoid high engine speeds with no load on the engine.
- Turn the engine off instead of letting it idle for an extended length of time (e.g., in traffic jams, at traffic lights or at railroad crossings).

5-3

OPERATION AND IMPORTANT RIDING POINTS

Engine break-in

There is never a more important period in the life of your engine than the period between 0 and 1000 km (600 mi). For this reason, you should read the following material carefully.

Since the engine is brand new, do not put an excessive load on it for the first 1000 km (600 mi). The various parts in the engine wear and polish themselves to the correct operating clearances. During this period, prolonged full-throttle operation or any condition that might result in engine overheating must be avoided.

0–150 km (0–90 mi)

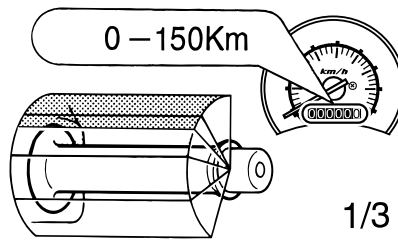

1/3

Avoid prolonged operation above 1/3 throttle.

After every hour of operation, stop the engine, and then let it cool for five to ten minutes.

Vary the engine speed from time to time. Do not operate the engine at one set throttle position.

150–500 km (90–300 mi)

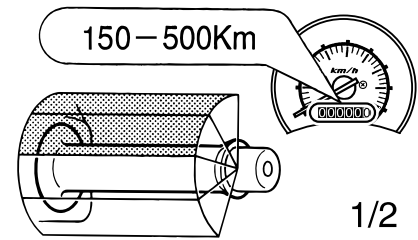

1/2

Avoid prolonged operation above 1/2 throttle.

Rev the engine freely through the gears, but do not use full throttle at any time.

OPERATION AND IMPORTANT RIDING POINTS

500–1000 km (300–600 mi)

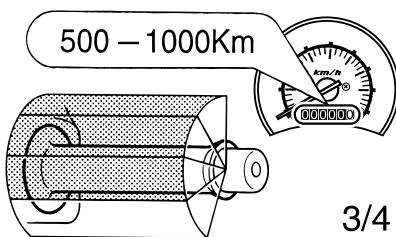

3/4

Avoid prolonged operation above 3/4 throttle.

1000 km (600 mi) and beyond

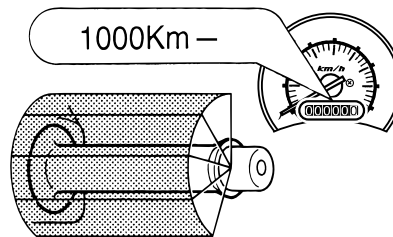

Avoid prolonged full-throttle operation. Vary the engine speed occasionally.

NOTICE: After 1000 km (600 mi) of operation, the engine oil must be changed, the oil filter cartridge or element replaced, and the oil strainer cleaned. If any engine trouble should occur during the engine break-in period, immediately have a Yamaha dealer check the vehicle.

Parking

When parking, stop the engine, and then remove the key from the main switch.

WARNING

- Since the engine and exhaust system can become very hot, park in a place where pedestrians or children are not likely to touch them.
- Do not park on a slope or on soft ground, otherwise the vehicle may overturn.

NOTICE

Never park in an area where there are fire hazards such as grass or other flammable materials.

OPERATION AND IMPORTANT RIDING POINTS

General note

Much can be gained from the correct use and maintenance of a motorcycle.

1. THE CUSTOMERS CAN USE THE FULLEST POTENTIAL OF YAMAHA MOTORCYCLES



2. A MOTORCYCLE CAN KEEP ITS PERFORMANCE CAPABILITY FOR A LONGER TIME

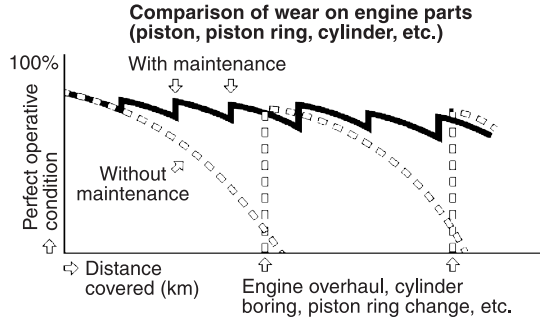

OPERATION AND IMPORTANT RIDING POINTS

3. FUEL COST AND REPAIR EXPENSES CAN BE KEPT TO A MINIMUM

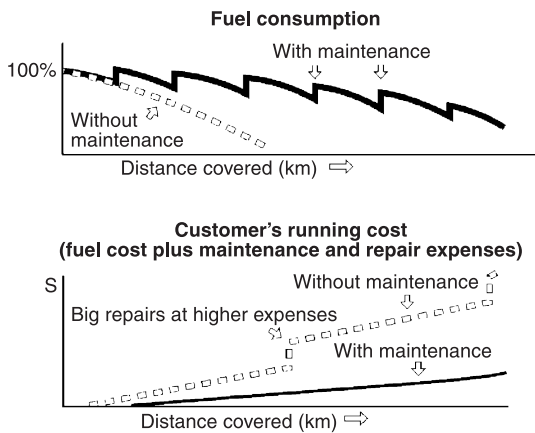

4. A MOTORCYCLE CAN DEMAND A HIGH PRICE WHEN IT IS TRADED IN AS A USED PRODUCT



PERIODIC MAINTENANCE AND MINOR REPAIR

Owner's tool kit

Safety is an obligation of the owner. Periodic inspection, adjustment and lubrication will keep your vehicle in the safest and most efficient condition possible. The most important points of inspection, adjustment, and lubrication are explained on the following pages. The intervals given in the periodic maintenance and lubrication chart should be simply considered as a general guide under normal riding conditions. However, **DEPENDING ON THE WEATHER, TERRAIN, GEOGRAPHICAL LOCATION, AND INDIVIDUAL USE, THE MAINTENANCE INTERVALS MAY NEED TO BE SHORTENED.**

! WARNING

If you are not familiar with maintenance work, have a Yamaha dealer do it for you.

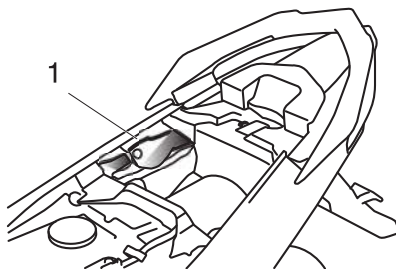

1. Owner's tool kit

The owner's tool kit is located inside the storage compartment under the seat. (See page 3-9.)

The service information included in this manual and the tools provided in the owner's tool kit are intended to assist you in the performance of preventive maintenance and minor repairs. However, additional tools such as a torque wrench may be necessary to perform certain maintenance work correctly.

TIP

If you do not have the tools or experience required for a particular job, have a Yamaha dealer perform it for you.

! WARNING

Modifications not approved by Yamaha may cause loss of performance and render the vehicle unsafe for use. Consult a Yamaha dealer before attempting any changes.

NOTICE

Improper disposal of drained fluids (i.e., oil, coolant, etc) and battery are harmful to the environment. Contact a Yamaha dealer for proper disposal to protect the environment.

PERIODIC MAINTENANCE AND MINOR REPAIR

Periodic maintenance and lubrication chart

TIP

- The annual checks must be performed every year, except if a kilometer-based maintenance is performed instead.
- From 12000 km, repeat the maintenance intervals starting from 3000 km.
- Items marked with an asterisk should be performed by a Yamaha dealer as they require special tools, data and technical skills

NO.	ITEM	CHECK OR MAINTENANCE JOB	ODOMETER READING (x 1000 km)					ANNUAL CHECK
			0.5	3	6	9	12	
1	* Fuel line	• Check fuel and vacuum hoses for cracks or damage.		√	√	√	√	√
2	Spark plug	• Check condition. • Clean and regap.		√		√		
		• Replace.			√		√	
3	* Valves	• Check valve clearance. • Adjust.				√		
4	Air filter element	• Clean.		√	√	√	√	
		• Replace.			√		√	
5	* Battery	• Check voltase and battery terminal.		√	√	√	√	√
6	* Front brake	• Check operation, fluid level and vehicle for fluid leakage.	√	√	√	√	√	√
		• Replace brake pads.	Whenever worn to the limit					
7	* Rear brake	• Check operation and adjust brake pedal free play.	√	√	√	√	√	?
		• Replace brake shoes.	Whenever worn to the limit					
8	* Brake hose	• Check for cracks or damage.		√	√	√	√	√
		• Replace.	Every 4 years					

PERIODIC MAINTENANCE AND MINOR REPAIR

NO.	ITEM	CHECK OR MAINTENANCE JOB	ODOMETER READING (x 1000 km)					ANNUAL CHECK
			0.5	3	6	9	12	
9	* Wheels	• Check runout and for damage.		√	√	√	√	
10	* Tires	• Check tread depth and for damage. • Replace if necessary. • Check air pressure. • Correct if necessary.		√	√	√	√	√
11	* Wheel bearings	• Check bearing for looseness or damage.		√	√	√	√	
12	* Swingarm	• Check operation and for excessive play. • Lubricate with lithium-soap-based grease.		√	√	√	√	
13	Drive chain	• Check chain slack, alignment and condition. • Adjust and thoroughly lubricate chain with engine oil.	Every 500 km and after washing the motorcycle or riding in the rain					
14	* Steering bearings	• Check bearing play and steering for roughness. • Lubricate with lithium-soap-based grease.	√	√	√	√	√	
15	* Chassis fasteners	• Make sure that all nuts, bolts and screws are properly tightened.		√	√	√	√	√
16	Sidestand, centerstand	• Check operation. • Lubricate.		√	√	√	√	√
17	* Front fork	• Check operation and for oil leakage.		√	√	√	√	
18	* Shock absorber assembly	• Check operation and shock absorber for oil leakage.		√	√	√	√	
19	* Carburetor	• Check starter (choke) operation. • Adjust engine idling speed.	√	√	√	√	√	√
20	Engine oil	• Change. • Check oil level and vehicle for oil leakage.	√	√	√	√	√	√
21	Engine oil filter element	• Replace.	√		√		√	

6-3

PERIODIC MAINTENANCE AND MINOR REPAIR

NO.	ITEM	CHECK OR MAINTENANCE JOB	ODOMETER READING (x 1000 km)					ANNUAL CHECK
			0.5	3	6	9	12	
22	* Cooling system	• Check coolant level and vehicle for coolant leakage. • Change.		√	√	√	√	√
23	* Front and rear brake switches	• Check operation.	√	√	√	√	√	√
24	Moving parts and cables	• Lubricate.		√	√	√	√	√
25	* Throttle grip housing and cable	• Check operation and free play. • Adjust the throttle cable free play if necessary. • Lubricate the throttle grip housing and cable.		√	√	√	√	√
26	* Air induction system	• Check the air cut-off valve, reed valve, and hose for damage. • Replace any damaged parts if necessary.		√	√	√	√	√
27	* Lights, signals and switches	• Check operation. • Adjust headlight beam.	√	√	√	√	√	√

TIP

- The air filter needs more frequent service if you are riding in unusually wet or dusty areas.
- Hydraulic brake service
 - Regularly check and, if necessary, correct the brake fluid level.
 - Every two years replace the internal components of the brake master cylinder and caliper, and change the brake fluid.
 - Replace the brake hoses every four years and if cracked or damaged.

6-4

PERIODIC MAINTENANCE AND MINOR REPAIR

Removing and installing the cowlings and panel

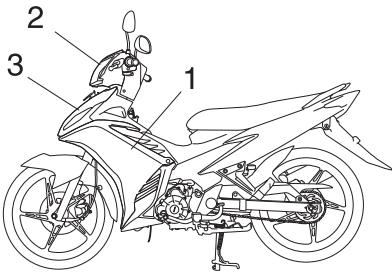

- 1. Cowling A
- 2. Cowling C
- 3. Cowling D

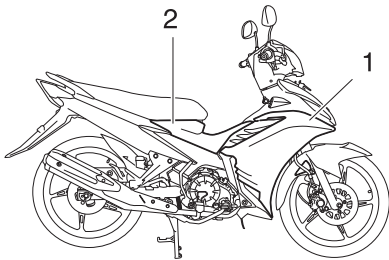

- 1. Cowling B
- 2. Panel A

The cowlings and panel shown above need to be removed to perform some of the maintenance jobs described in this chapter. Refer to this section each time a cowling or the panel needs to be removed and installed.

Cowlings A and B

To remove one of the cowlings
Remove the cowling bolts, and then pull the cowling off as shown.

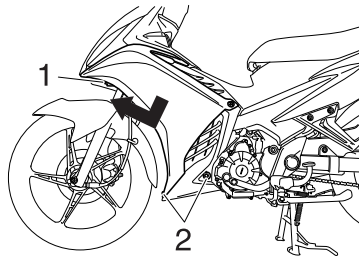

- 1. Cowling A
- 2. Bolt

To install the cowling
Place the cowling in the original position, and then install the bolts.

6-5

Cowling C

To remove the cowling
Remove the bolts and screw shown, and then take the cowling off.

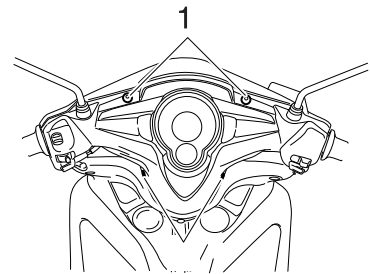

- 1. Bolt

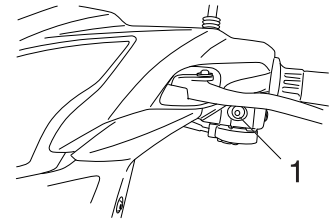

- 1. Bolt

PERIODIC MAINTENANCE AND MINOR REPAIR

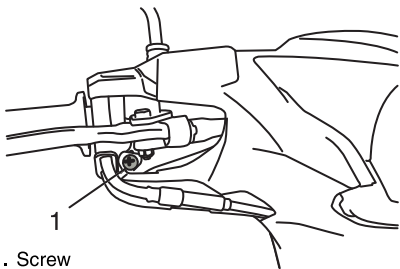

- 1. Screw

To install the cowling

Place the cowling in the original position, and then install the bolts and screw.

Cowling D

To remove the cowling

1. Remove cowlings A and B. (See page 6-5.)
2. Remove the bolts and screws shown, and then take the license bracket plate and the cowling off.

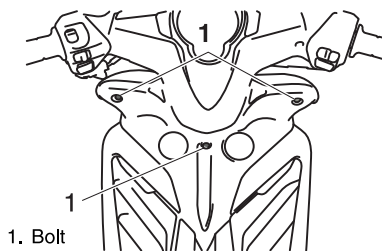

- 1. Bolt

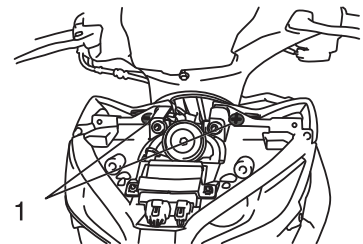

- 1. Screw

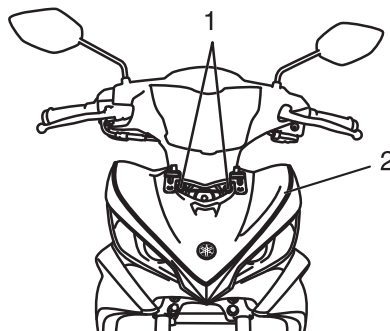

- 1. Screw
- 2. Cowling A

To install the cowling

1. Place the cowling in the original position, and then install the bolts and screws.
2. Install cowlings A and B.

PERIODIC MAINTENANCE AND MINOR REPAIR

Panel A

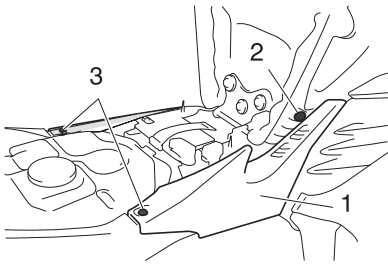

1. Panel A
2. Screw
3. Bolt

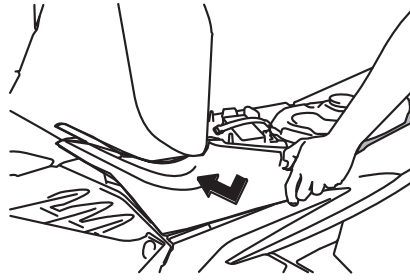

To remove the panel

1. Open the seat. (See page 3-9.)
2. Remove the screw and bolts, and then pull the panel off as shown.

To install the panel

Place the panel in the original position, and then install the screw and bolts.

Checking the spark plug

The spark plug is an important engine component, which is easy to check. Since heat and deposits will cause any spark plug to slowly erode, the spark plug should be removed and checked in accordance with the periodic maintenance and lubrication chart. In addition, the condition of the spark plug can reveal the condition of the engine.

6-7

PERIODIC MAINTENANCE AND MINOR REPAIR

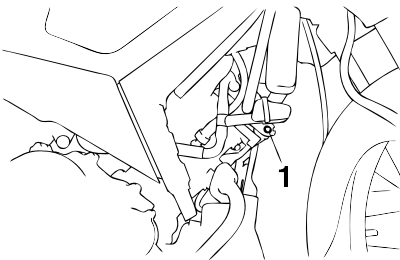

1. Resonator bolt

To remove the spark plug

1. Remove cowling B. (See page 6-5.)
2. Remove the resonator bolt.

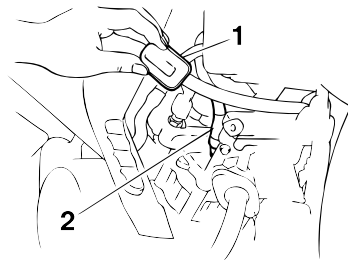

1. Resonator
2. Spark plug cap

3. Move the resonator away as shown.
4. Remove the spark plug cap.

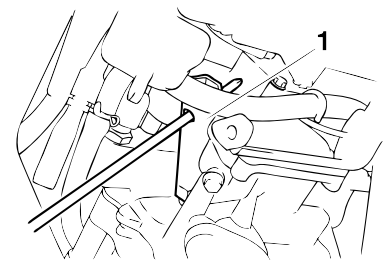

1. Spark plug wrench

5. Remove the spark plug as shown, with the spark plug wrench included in the owner's tool kit.

6-8

PERIODIC MAINTENANCE AND MINOR REPAIR

To check the spark plug

1. Check that the porcelain insulator around the center electrode of the spark plug is a medium-to-light tan (the ideal color when the vehicle is ridden normally).

TIP

If the spark plug shows a distinctly different color, the engine could be defective. Do not attempt to diagnose such problems yourself. Instead, have a Yamaha dealer check the vehicle.

2. Check the spark plug for electrode erosion and excessive carbon or other deposits, and replace it if necessary.

Specified spark plug:
NGK/CPR8EA-9/DENSO U24EPR-9

To install the spark plug

1. Measure the spark plug gap with a wire thickness gauge and, if necessary, adjust the gap to specification.

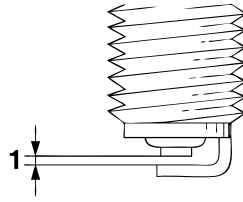

1. Spark plug gap

Spark plug gap:
0.8–0.9 mm (0.031–0.035 in)

2. Clean the surface of the spark plug gasket and its mating surface, and then wipe off any grime from the spark plug threads.
3. Install the spark plug with the spark plug wrench, and then tighten it to the specified torque.

Tightening torque:
Spark plug:
12.5 Nm (1.25 m·kgf, 9.0 ft·lbf)

TIP

If a torque wrench is not available when installing a spark plug, a good estimate of the correct torque is 1/4–1/2 turn past finger tight. However, the spark plug should be tightened to the specified torque as soon as possible.

4. Install the spark plug cap.
5. Place the resonator in the original position, and then tighten the bolt to the specified torque.

Tightening torque:
Resonator bolt:
10 Nm (1.0 m·kgf, 7.2 ft·lbf)

6. Install the cowl.

6-9

PERIODIC MAINTENANCE AND MINOR REPAIR

Engine oil and oil filter element

The engine oil level should be checked before each ride. In addition, the oil must be changed and the oil filter element replaced at the intervals specified in the periodic maintenance and lubrication chart.

To check the engine oil level

1. Place the vehicle on the centerstand. A slight tilt to the side can result in a false reading.
2. Start the engine, warm it up for several minutes, and then turn it off.

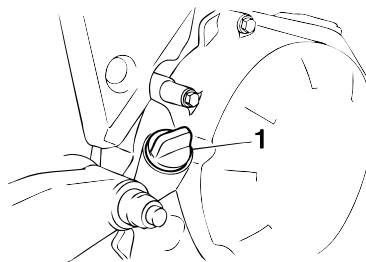

1. Engine oil filler cap

3. Wait a few minutes until the oil settles, remove the oil filler cap, wipe the dipstick clean, insert it back into the oil filler hole (without screwing it in), and then remove it again to check the oil level.

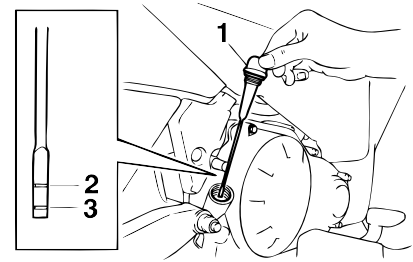

1. Dipstick
2. Maximum level mark
3. Minimum level mark

TIP

The engine oil should be between the minimum and maximum level marks.

4. If the engine oil is at or below the minimum level mark, add sufficient oil of the recommended type to raise it to the correct level.
5. Insert the dipstick into the oil filler hole, and then tighten the oil filler cap.

6-10

PERIODIC MAINTENANCE AND MINOR REPAIR

To change the engine oil (with or without oil filter element replacement)

1. Start the engine, warm it up for several minutes, and then turn it off.
2. Place an oil pan under the engine to collect the used oil.
3. Remove the engine oil filler cap and drain bolt along with the O-ring, compression spring, and engine oil strainer, to drain the oil from the crankcase. **NOTICE:** When removing the engine oil drain bolt, the O-ring, compression spring, and oil strainer will fall out. Take care not to lose these parts.

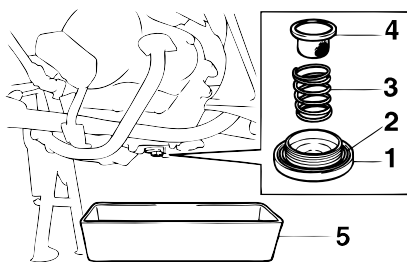

1. Engine oil drain bolt
2. O-ring
3. Compression spring
4. Strainer
5. Oil pan

TIP

Check the O-ring for damage and replace it if necessary.

4. Clean the engine oil strainer with solvent.

TIP

Skip steps 5–7 if the oil filter element is not being replaced.

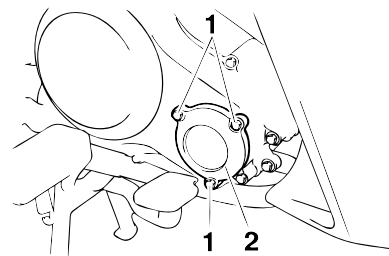

1. Bolt
2. Oil filter element cover
5. Remove the oil filter element cover by removing the bolts.
6. Remove and replace the oil filter element and O-ring.

6-11

PERIODIC MAINTENANCE AND MINOR REPAIR

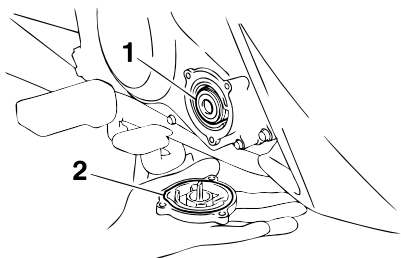

1. Oil filter element
2. O-ring

7. Install the oil filter element cover by installing the bolts, then tightening them to the specified torque.

Tightening torque:

Oil filter element cover bolt:
10 Nm (1.0 m·kgf, 7.2 ft·lbf)

TIP

Make sure that the O-ring is properly seated.

8. Install the engine oil strainer, compression spring, O-ring and engine oil drain bolt, and then tighten the drain bolt to the specified torque. **NOTICE:** Before installing the engine oil drain bolt, do not forget to install the O-ring, compression spring, and oil strainer in position.

Tightening torque:

Engine oil drain bolt:
32 Nm (3.2 m·kgf, 23 ft·lbf)

9. Refill with the specified amount of the recommended engine oil, and then install and tighten the oil filler cap.

Recommended engine oil:

See page 8-1.

Oil quantity:

With oil filter element replacement:
0.90 L (0.95 US qt, 0.79 Imp.qt)
Without oil filter element replacement:
0.80 L (0.85 US qt, 0.70 Imp.qt)

6

6-12

PERIODIC MAINTENANCE AND MINOR REPAIR

TIP

Be sure to wipe off spilled oil on any parts after the engine and exhaust system have cooled down.

NOTICE

- **Yamalube 4T SJ, 20W-50 MA or SAE 20W-40 or SAE 20W-50. Recommended engine oil grade: API service SF, SG, type or higher JASO MA.**
- **Make sure that no foreign material enters the crankcase.**

10. Start the engine, and then let it idle for several minutes while checking it for oil leakage. If oil is leaking, immediately turn the engine off and check for the cause.
11. Turn the engine off, and then check the oil level and correct it if necessary.

Coolant

The coolant level should be checked before each ride. In addition, the coolant must be changed at the intervals specified in the periodic maintenance and lubrication chart.

To check the coolant level

The coolant level should be checked as follows before each ride. In addition, the coolant must be changed at the intervals specified in the periodic maintenance and lubrication chart.

1. Place the vehicle on the center-stand.

TIP

- The coolant level must be checked on a cold engine since the level varies with engine temperature.
- Make sure that the vehicle is positioned straight up when checking the coolant level. A slight tilt to the side can result in a false reading.

2. Check the coolant level in the coolant reservoir.

6-13

PERIODIC MAINTENANCE AND MINOR REPAIR

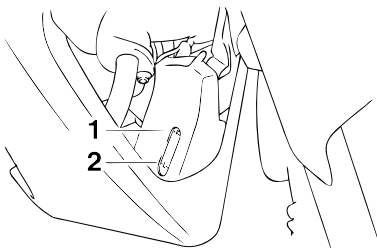

1. Maximum level mark
2. Minimum level mark

TIP

The coolant should be between the minimum and maximum level marks.

3. If the coolant is at or below the minimum level mark, remove cowl-
ing A. (See page 6-5.)
4. Loosen the coolant reservoir cap
retainer bolt, and then lift the re-
tainer upward.
5. Remove the coolant reservoir
cap, and then add coolant to the
maximum level mark. **WARNING!**
Remove only the coolant reser-

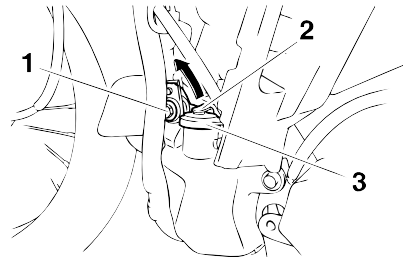

1. Coolant reservoir cap retainer bolt
2. Coolant reservoir cap retainer
3. Coolant reservoir cap

**voir cap. Never attempt to re-
move the radiator cap when the
engine is hot. NOTICE: If
coolant is not available, use
distilled water or soft tap water
instead. Do not use hard water
or salt water since it is harmful
to the engine. If water has been
used instead of coolant, re-
place it with coolant as soon as
possible, otherwise the cooling**

system will not be protected
against frost and corrosion. If
water has been added to the
coolant, have a Yamaha dealer
check the antifreeze content of
the coolant as soon as possi-
ble, otherwise the effective-
ness of the coolant will be
reduced.

Coolant reservoir capacity (up to the maximum level mark):

0.28 L (0.30 US qt, 0.25 Imp.qt)

6. Install the coolant reservoir cap.
7. Place the coolant reservoir cap re-
tainer in the original position, and
then tighten the bolt to the speci-
fied torque.

Tightening torque:

Coolant reservoir cap retainer bolt:
7 Nm (0.7 m·kgf, 5 ft·lbf)

8. Install the cowl-
ing.

6-14

PERIODIC MAINTENANCE AND MINOR REPAIR

Changing the coolant

The coolant must be changed at the intervals specified in the periodic maintenance and lubrication chart. Have a Yamaha dealer change the coolant. **WARNING! Never attempt to remove the radiator cap when the engine is hot.**

Cleaning the air filter element

The air filter element should be cleaned at the intervals specified in the periodic maintenance and lubrication chart. Clean the air filter element more frequently if you are riding in unusually wet or dusty areas.

1. Remove panel A. (See page 6-7.)
2. Remove the air filter case cover by removing the screws and clamp, and then pull the air filter element out.

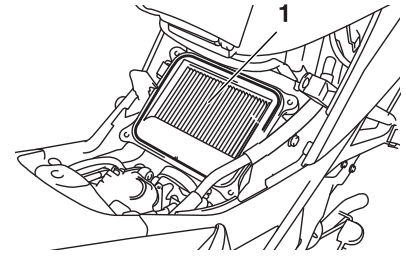

1. Air filter element

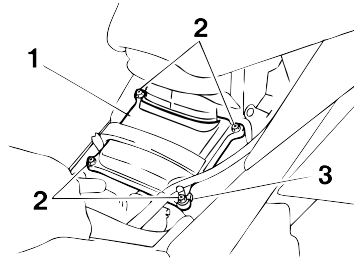

1. Air filter case cover
2. Screw
3. Clamp

6-15

PERIODIC MAINTENANCE AND MINOR REPAIR

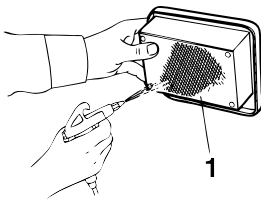

1. Air filter element

3. Lightly tap the air filter element to remove most of the dust and dirt, and then blow the remaining dirt out with compressed air as shown. If the air filter element is damaged, replace it.

4. Insert the air filter element into the air filter case with the arrow mark on the top pointing inward. **NOTICE: Make sure that the air filter element is properly seated in the air filter case. The engine should never be operated without the air filter element installed, otherwise the piston(s) and/or cylinder(s) may become excessively worn.**

5. Install the air filter case cover by installing the screws.

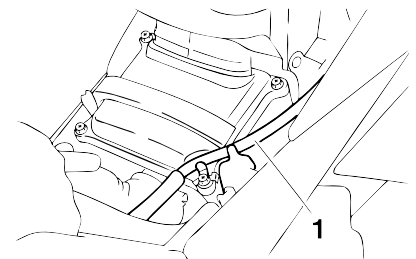

1. Carburetor air vent hose

TIP

- Make sure that the carburetor air vent hose is routed as shown.
- If dust or water collects in the air filter check hose, remove the clamp from it, and then remove the plug to drain the hose.

6-16

PERIODIC MAINTENANCE AND MINOR REPAIR

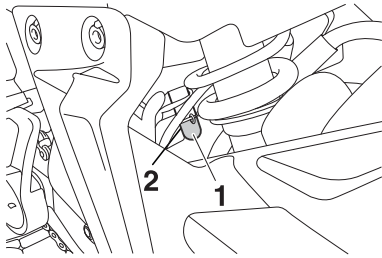

1. Air filter check hose
2. Clamp

6. Install the panel.

6

Adjusting the carburetor

The carburetor is an important part of the engine and requires very sophisticated adjustment. Therefore, most carburetor adjustments should be left to a Yamaha dealer, who has the necessary professional knowledge and experience. The adjustment described in the following section, however, may be serviced by the owner as part of routine maintenance.

NOTICE

The carburetor has been set and extensively tested at the Yamaha factory. Changing these settings without sufficient technical knowledge may result in poor performance of or damage to the engine.

Adjusting the engine idling speed

The engine idling speed must be checked and, if necessary, adjusted as follows at the intervals specified in the periodic maintenance and lubrication chart.

The engine should be warm before making this adjustment.

TIP

- The engine is warm when it quickly responds to the throttle.
- A diagnostic tachometer is needed to make this adjustment.

1. Remove cowling B. (See page 6-5.)
2. Attach the diagnostic tachometer to the spark plug lead.

6-17

PERIODIC MAINTENANCE AND MINOR REPAIR

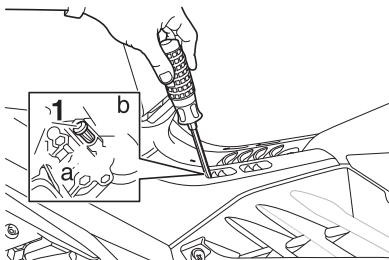

1. Throttle stop screw

3. Check the engine idling speed and, if necessary, adjust it to specification by turning the throttle stop screw. To increase the engine idling speed, turn the screw in direction (a). To decrease the engine idling speed, turn the screw in direction (b).

Engine idling speed:
1300–1500 r/min

TIP:

If the specified idling speed cannot be obtained as described above, have a Yamaha dealer make the adjustment.

4. Install the cowling.

Adjusting the throttle cable free play

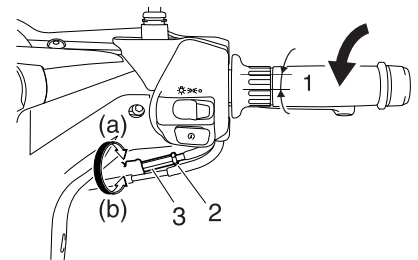

1. Throttle cable free play
2. Locknut
3. Adjusting nut

The throttle cable free play should measure 3.0–7.0 mm (0.12–0.28 in) at the throttle grip. Periodically check the throttle cable free play and, if necessary, adjust it as follows.

TIP

The engine idling speed must be correctly adjusted before checking and adjusting the throttle cable free play.

1. Loosen the locknut.

6

6-18

PERIODIC MAINTENANCE AND MINOR REPAIR

- To increase the throttle cable free play, turn the adjusting nut in direction (a). To decrease the throttle cable free play, turn the adjusting nut in direction (b).
- Tighten the locknut.

Valve clearance

The valve clearance changes with use, resulting in improper air-fuel mixture and/or engine noise. To prevent this from occurring, the valve clearance must be adjusted by a Yamaha dealer at the intervals specified in the periodic maintenance and lubrication chart.

Tires

To maximize the performance, durability, and safe operation of your motorcycle, note the following points regarding the specified tires.

Tire air pressure

The tire air pressure should be checked and, if necessary, adjusted before each ride.

WARNING

- The tire air pressure must be checked and adjusted on cold tires (i.e., when the temperature of the tires equals the ambient temperature).
- The tire air pressure must be adjusted in accordance with the riding speed and with the total weight of rider, passenger, cargo, and accessories approved for this model.

6-19

PERIODIC MAINTENANCE AND MINOR REPAIR

Tire air pressure (measured on cold tires):

0–90 kg (0–198 lb):

Front:

200 kPa (29 psi) (2.00 kgf/cm²)

Rear:

225 kPa (33 psi) (2.25 kgf/cm²)

90–150 kg (198–331 lb):

Front:

200 kPa (29 psi) (2.00 kgf/cm²)

Rear:

225 kPa (33 psi) (2.25 kgf/cm²)

Maximum load*:

150 kg (331 lb)

* Total weight of rider, passenger, cargo and accessories

WARNING

Proper loading of your motorcycle is important for several characteristics of your motorcycle; such as handling, braking, performance and safety. Do not carry loosely packed items that can shift. Securely pack your heaviest items close to the center of the motorcycle, and distribute

the weight evenly from side to side. Check the condition and pressure of your tires. **NEVER OVERLOAD YOUR MOTORCYCLE.** Make sure the total weight of the cargo, rider, passenger, and accessories (fairing, saddlebags, etc. if approved for this model) does not exceed the maximum load of the motorcycle. Operation of an overloaded motorcycle could cause tire damage, an accident, or even injury.

Tire inspection

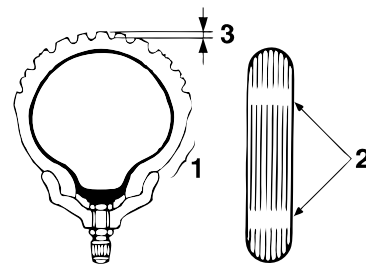

- Tire sidewall
- Tire wear indicator
- Tire tread depth

The tires must be checked before each ride. If the tire shows crosswise lines (minimum tread depth), if the tire has a nail or glass fragments in it, or if the sidewall is cracked, have a Yamaha dealer replace the tire immediately.

Minimum tire tread depth (front and rear):

1.0 mm (0.04 in)

TIP

The tire tread depth limits may differ from country to country. Always comply with the local regulations.

6-20

PERIODIC MAINTENANCE AND MINOR REPAIR

Tire information

This motorcycle is equipped with tubeless tires.

WARNING

- The front and rear tires should be of the same make and design, otherwise the handling characteristics of the vehicle cannot be guaranteed.
- After extensive tests, only the tires listed below have been approved for this model by Yamaha Motor Co., Ltd.

Front tire:

Size: 70/90-17M/C 38P
Manufacturer/model:
Vee Rubber/V322F

Rear tire:

Size: 80/90-17M/C 44P
Manufacturer/model:
Vee Rubber/V322F

WARNING

- It is dangerous to ride with a worn-out tire. When a tire tread begins to show crosswise lines, have a Yamaha dealer replace the tire immediately.
- The replacement of all wheel- and brake-related parts, including the tires, should be left to a Yamaha dealer, who has the necessary professional knowledge and experience.

Wheels

To maximize the performance, durability, and safe operation of your motorcycle, note the following points regarding the specified wheels.

- The wheel rims should be checked for cracks, bends or warpage, and the spokes for looseness or damage before each ride. If any damage is found, have a Yamaha dealer replace the wheel. Do not attempt even the smallest repair to the wheel. A deformed or cracked wheel must be replaced.
- The wheel should be balanced whenever either the tire or wheel has been changed or replaced. An unbalanced wheel can result in poor performance, adverse handling characteristics, and a shortened tire life.
- Ride at moderate speeds after changing a tire since the tire surface must first be "broken in" for it to develop its optimal characteristics.

6-21

PERIODIC MAINTENANCE AND MINOR REPAIR

Checking the brake lever free play

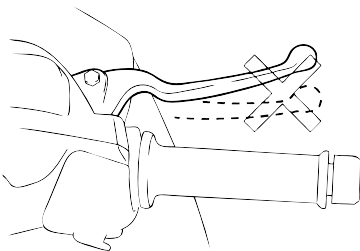

There should be no free play at the brake lever end. If there is free play, have a Yamaha dealer inspect the brake system.

WARNING

A soft or spongy feeling in the brake lever can indicate the presence of air in the hydraulic system. If there is air in the hydraulic system, have a Yamaha dealer bleed the system before operating the motorcycle. Air in the hydraulic system will diminish the braking performance, which may result in loss of control and an accident.

Adjusting the brake pedal free play

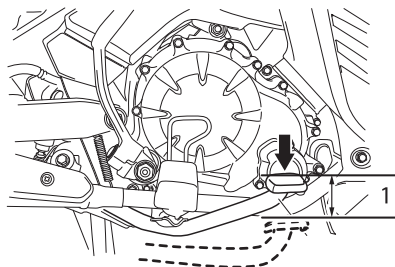

1. Brake pedal free play

The brake pedal free play should measure 25.0–35.0 mm (0.98–1.38 in) at the brake pedal end as shown. Periodically check the brake pedal free play and, if necessary, adjust it as follows. To increase the brake pedal free play, turn the adjusting nut in direction (a). To decrease the brake pedal free play, turn the adjusting nut in direction (b).

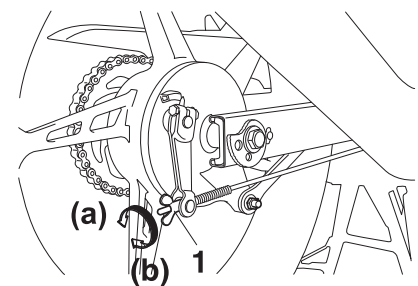

1. Brake pedal free play adjusting nut

WARNING

- After adjusting the drive chain slack or removing and installing the rear wheel, always check the brake pedal free play.
- If proper adjustment cannot be obtained as described, have a Yamaha dealer make this adjustment.
- After adjusting the brake pedal free play, check the operation of the brake light.

6-22

PERIODIC MAINTENANCE AND MINOR REPAIR

Adjusting the rear brake light switch

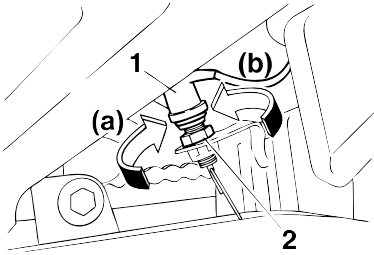

1. Rear brake light switch
2. Rear brake light switch adjusting nut

The rear brake light switch, which is activated by the brake pedal, is properly adjusted when the brake light comes on just before braking takes effect. If necessary, adjust the brake light switch as follows.

Turn the adjusting nut while holding the rear brake light switch in place. To make the brake light come on earlier, turn the adjusting nut in direction (a). To make the brake light come on later, turn the adjusting nut in direction (b).

Checking the front brake pads and rear brake shoes

The front brake pads and the rear brake shoes must be checked for wear at the intervals specified in the periodic maintenance and lubrication chart.

Front brake pads

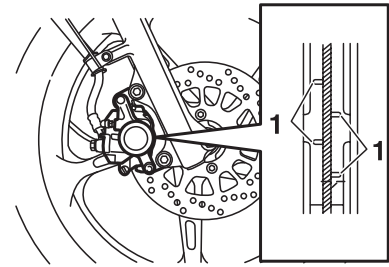

1. Brake pad wear indicator groove

Each front brake pad is provided with wear indicator grooves, which allow you to check the brake pad wear without having to disassemble the brake. To check the brake pad wear, check the wear indicator grooves. If a brake pad has worn to the point that the wear indicator grooves have almost disappeared, have a Yamaha dealer replace the brake pads as a set.

6-23

PERIODIC MAINTENANCE AND MINOR REPAIR

Rear brake shoes

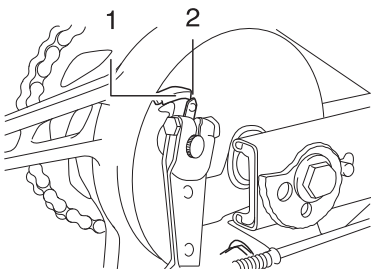

1. Brake shoe wear limit line
2. Brake shoe wear indicator

The rear brake is provided with a wear indicator, which allows you to check the brake shoe wear without having to disassemble the brake. To check the brake shoe wear, check the position of the wear indicator while applying the brake. If a brake shoe has worn to the point that the wear indicator reaches the wear limit line, have a Yamaha dealer replace the brake shoes as a set.

Checking the front brake fluid level

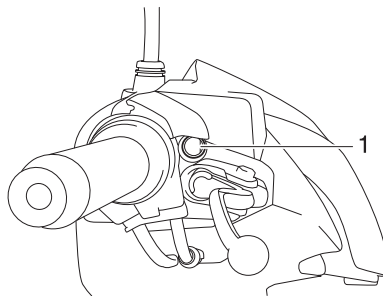

1. Minimum level mark

Insufficient brake fluid may allow air to enter the brake system, possibly causing it to become ineffective.

Before riding, check that the brake fluid is above the minimum level mark and replenish if necessary. A low brake fluid level may indicate worn brake pads and/or brake system leakage. If the brake fluid level is low, be sure to check the brake pads for wear and the brake system for leakage.

Observe these precautions:

- When checking the fluid level, make sure that the top of the master cylinder is level by turning the handlebars.
- Use only the recommended quality brake fluid, otherwise the rubber seals may deteriorate, causing leakage and poor braking performance.

Recommended brake fluid:
DOT 4

TIP: If DOT 4 is not available, DOT 3 can be used.

- Refill with the same type of brake fluid. Mixing fluids may result in a harmful chemical reaction and lead to poor braking performance.
- Be careful that water does not enter the master cylinder when refilling. Water will significantly lower the boiling point of the fluid and may result in vapor lock.

6-24

PERIODIC MAINTENANCE AND MINOR REPAIR

- Brake fluid may deteriorate painted surfaces or plastic parts. Always clean up spilled fluid immediately.
- As the brake pads wear, it is normal for the brake fluid level to gradually go down. However, if the brake fluid level goes down suddenly, have a Yamaha dealer check the cause.

Changing the brake fluid

Have a Yamaha dealer change the brake fluid at the intervals specified in the NOTE after the periodic maintenance and lubrication chart. In addition, have the oil seals of the brake master cylinder and caliper as well as the brake hose replaced at the intervals listed below or whenever they are damaged or leaking.

- Oil seals: Replace every two years.
- Brake hose: Replace every four years.

Drive chain slack

The drive chain slack should be checked before each ride and adjusted if necessary.

To check the drive chain slack

1. Place the motorcycle on the centerstand.
2. Shift the transmission into the neutral position.
3. Spin the rear wheel several times to locate the tightest portion of the drive chain.
4. Measure the drive chain slack as shown.

PERIODIC MAINTENANCE AND MINOR REPAIR

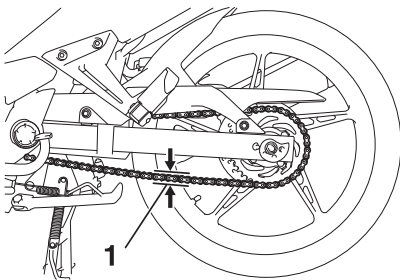

1. Drive chain slack

Drive chain slack :
25.0–35.0 mm (0.98–1.38 in)

5. If the drive chain slack is incorrect, adjust it as follows.

To adjust the drive chain slack

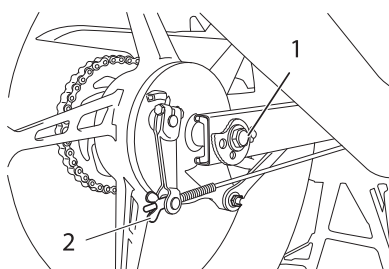

1. Brake pedal free play adjusting nut
2. Axle nut

1. Loosen the brake pedal free play adjusting nut.
2. Loosen the axle nut, and brake torque rod nut.
3. To tighten the drive chain, turn the drive chain slack adjusting plate on each side of the swing arm in direction (a). To loosen the drive chain, turn the adjusting plate on each side of the swingarm in direction (b), and then push the rear wheel forward. **NOTICE:** Impro-

Right side

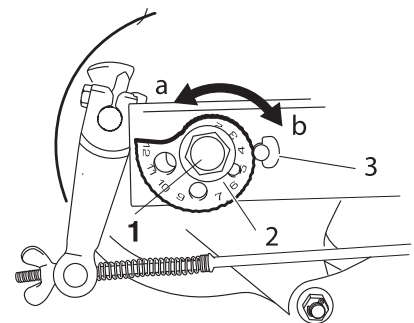

1. Axle nut
2. Adjusting plate
3. Stopper alignment.

per drive chain slack will overload the engine as well as other vital parts of the motorcycle and can lead to chain slippage or breakage. To prevent this from occurring, keep the drive chain slack within the specified limits.

PERIODIC MAINTENANCE AND MINOR REPAIR

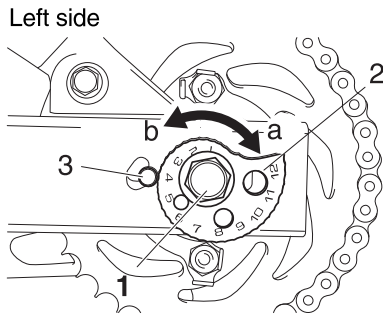

1. Axle nut
2. Adjusting plate
3. Stopper alignment.

TIP:

Make sure that both adjusting plates are in the same position for proper wheel alignment.

4. Tighten the axle nut and brake torque rod nut to the specified torques.

Tightening torques:

- Axle nut:
60 Nm (6.0 m-kgf, 43 ft-lbf)
- Brake torque rod nut:
19 Nm (1.9 m-kgf, 14 ft-lbf)

5. Adjust the brake pedal free play. (See page 6-22.)

⚠ WARNING

After adjusting the brake pedal free play, check the operation of the brake light.

Cleaning and lubricating the drive chain

The drive chain must be cleaned and lubricated at the intervals specified in the periodic maintenance and lubrication chart, otherwise it will quickly wear out, especially when riding in dusty or wet areas. Service the drive chain as follows.

NOTICE

The drive chain must be lubricated after washing the motorcycle and riding in the rain.

1. Remove all dirt and mud from the drive chain with a brush or cloth.

TIP :

For a thorough cleaning, have a Yamaha dealer remove the drive chain and soak it in solvent.

6-27

PERIODIC MAINTENANCE AND MINOR REPAIR

2. Spray Yamaha Chain and Cable Lube or a high-quality spray-type drive chain lubricant on both sides and on the middle of the chain, making sure that all side plates and rollers have been sufficiently oiled.

Checking and lubricating the cables

The operation of all control cables and the condition of the cables should be checked before each ride, and the cables and cable ends should be lubricated if necessary. If a cable is damaged or does not move smoothly, have a Yamaha dealer check or replace it.

Recommended lubricant:
Engine oil

⚠ WARNING

Damage to the outer sheath may interfere with proper cable operation and will cause the inner cable to rust. Replace a damaged cable as soon as possible to prevent unsafe conditions.

Checking and lubricating the throttle grip and cable

The operation of the throttle grip should be checked before each ride. In addition, the cable should be lubricated at the intervals specified in the periodic maintenance chart.

6

6-28

PERIODIC MAINTENANCE AND MINOR REPAIR

Checking and lubricating the brake lever

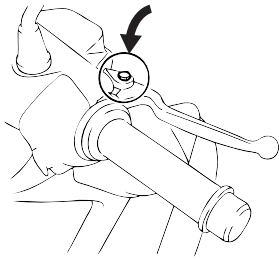

6

The operation of the brake lever should be checked before each ride, and the lever pivots should be lubricated if necessary.

Recommended lubricant:
Engine oil

Lubricating the brake pedal

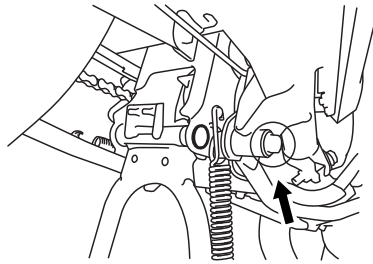

The operation of the brake pedal should be checked before each ride, and the pedal pivot should be lubricated if necessary.

Recommended lubricant:
Lithium-soap-based grease (all-purpose grease)

Checking and lubricating the centerstand and sidestand

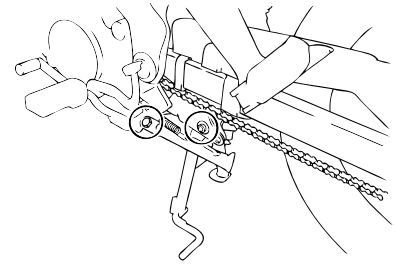

The operation of the centerstand and sidestand should be checked before each ride, and the pivots and metal-to-metal contact surfaces should be lubricated if necessary.

WARNING

If the centerstand or sidestand does not move up and down smoothly, have a Yamaha dealer check or repair it.

Recommended lubricant:
Lithium-soap-based grease (all-purpose grease)

6-29

PERIODIC MAINTENANCE AND MINOR REPAIR

Lubricating the swingarm pivots

The swingarm pivots must be lubricated at the intervals specified in the periodic maintenance and lubrication chart.

Recommended lubricant:
Lithium-soap-based grease

Checking the front fork

The condition and operation of the front fork must be checked as follows at the intervals specified in the periodic maintenance and lubrication chart.

To check the condition

Check the inner tubes for scratches, damage and excessive oil leakage.

To check the operation

1. Place the vehicle on a level surface and hold it in an upright position. **WARNING! To avoid injury securely support the vehicle so that there is no danger of it falling over.**
2. While applying the front brake, push down hard on the handlebars several times to check if the front fork compresses and rebounds smoothly.

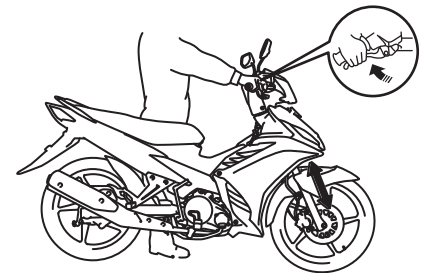

NOTICE

If any damage is found or the front fork does not operate smoothly, have a Yamaha dealer check or repair it.

6

6-30

PERIODIC MAINTENANCE AND MINOR REPAIR

Checking the steering

Worn or loose steering bearings may cause danger. Therefore, the operation of the steering must be checked as follows at the intervals specified in the periodic maintenance and lubrication chart.

1. Place a stand under the engine to raise the front wheel off the ground.
WARNING! To avoid injury securely support the vehicle so that there is no danger of it falling over.
2. Hold the lower ends of the front fork legs and try to move them forward and backward. If any free play can be felt, have a Yamaha dealer check or repair the steering.

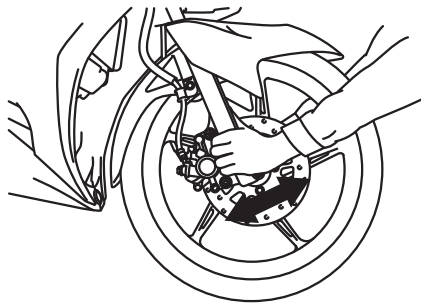

Checking the wheel bearings

The front and rear wheel bearings must be checked at the intervals specified in the periodic maintenance and lubrication chart. If there is play in the wheel hub or if the wheel does not turn smoothly, have a Yamaha dealer check the wheel bearings.

6

6-31

PERIODIC MAINTENANCE AND MINOR REPAIR

Battery

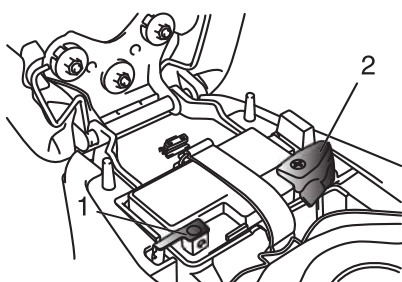

1. Negative battery lead
2. Positive battery lead

This model is equipped with a VRLA (Valve Regulated Lead Acid) battery. There is no need to check the electrolyte or to add distilled water. However, the battery lead connections need to be checked and, if necessary, tightened.

NOTICE

Never attempt to remove the battery cell seals, as this would permanently damage the battery.

WARNING

- Electrolyte is poisonous and dangerous since it contains sulfuric acid, which causes severe burns. Avoid any contact with skin, eyes or clothing and always shield your eyes when working near batteries. In case of contact, administer the following FIRST AID.
 - **EXTERNAL:** Flush with plenty of water.
 - **INTERNAL:** Drink large quantities of water or milk and immediately call a physician.
 - **EYES:** Flush with water for 15 minutes and seek prompt medical attention.
- Batteries produce explosive hydrogen gas. Therefore, keep sparks, flames, cigarettes, etc., away from the battery and provide sufficient ventilation when charging it in an enclosed space.

- **KEEP THIS AND ALL BATTERIES OUT OF THE REACH OF CHILDREN.**

To charge the battery

Have a Yamaha dealer charge the battery as soon as possible if it seems to have discharged. Keep in mind that the battery tends to discharge more quickly if the vehicle is equipped with optional electrical accessories.

NOTICE

To charge a VRLA (Valve Regulated Lead Acid) battery, a special (constant-voltage) battery charger is required. Using a conventional battery charger will damage the battery. If you do not have access to a constant-voltage battery charger, have a Yamaha dealer charge your battery.

6

6-32

PERIODIC MAINTENANCE AND MINOR REPAIR

To store the battery

1. If the vehicle will not be used for more than one month, remove the battery, fully charge it, and then place it in a cool, dry place. **NOTICE:** When removing the battery, be sure the key is turned to "OFF", then disconnect the negative lead before disconnecting the positive lead.
2. If the battery will be stored for more than two months, check it at least once a month and fully charge it if necessary.
3. Fully charge the battery before installation.
4. After installation, make sure that the battery leads are properly connected to the battery terminals.

NOTICE

Always keep the battery charged. Storing a discharged battery can cause permanent battery damage.

Replacing the fuse

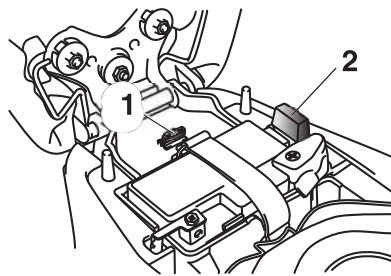

1. Spare fuse
2. Fuse

The fuse holder is located under the seat. (See page 3-9.)

If the fuse is blown, replace it as follows.

1. Turn the key to "OFF" and turn off all electrical circuits.

2. Remove the blown fuse, and then install a new fuse of the specified amperage. **WARNING !:** Do not use a fuse of a higher amperage rating than recommended to avoid causing extensive damage to the electrical system and possibly a fire.

Specified fuse:
10.0 A

3. Turn the key to "ON" and turn on the electrical circuits to check if the devices operate.
4. If the fuse immediately blows again, have a Yamaha dealer check the electrical system.

PERIODIC MAINTENANCE AND MINOR REPAIR

Replacing a headlight bulb

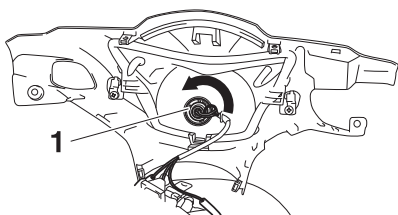

1. Headlight bulb holder

If a headlight bulb burns out, replace as follows.

1. Remove cowling A. (See page 6-5.)
2. Remove the headlight bulb holder by pushing it inward and turning counterclockwise, and then remove the defective bulb.

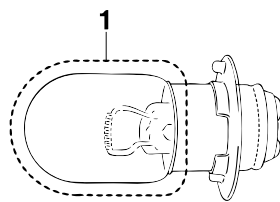

1. Do not touch the glass part of the bulb.

WARNING

Headlight bulbs get very hot. Therefore, keep flammable products away from a lit headlight bulb, and do not touch the bulb until it has cooled down.

3. Place a new bulb into position, and then secure it with the bulb holder.

NOTICE

Do not touch the glass part of the headlight bulb to keep it free from oil, otherwise the transparency of the glass, the luminosity of the bulb, and the bulb life will be adversely affected. Thoroughly clean off any dirt and fingerprints on the headlight bulb using a cloth moistened with alcohol or thinner.

4. Install the cowling.
5. Have a Yamaha dealer adjust the headlight beam if necessary.

PERIODIC MAINTENANCE AND MINOR REPAIR

Replacing a front turn signal light bulb or an auxiliary light bulb

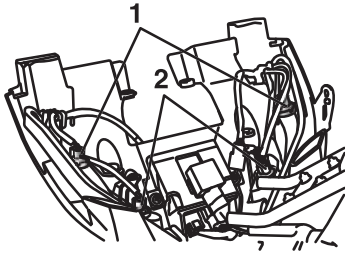

1. Turn signal light bulb socket
2. Auxiliary light bulb socket

If a front turn signal light or an auxiliary light bulb burns out, replace it as follows.

1. Remove front panel and cowlings B, (See page 6-5.)
2. Remove the socket (together with the bulb) by turning it counter-clockwise.

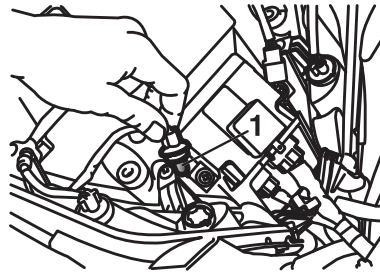

1. Bulb

3. Remove the defective bulb by pulling it out.
4. Insert a new bulb into the socket.
5. Install the socket (together with the bulb) by turning it clockwise.
6. Install the cowlings.

Rear turn signal light and tail/brake light

If a rear turn signal light or the tail/brake light does not come on, have a Yamaha dealer check its electrical circuit or replace the bulb.

6-35

PERIODIC MAINTENANCE AND MINOR REPAIR

Front wheel

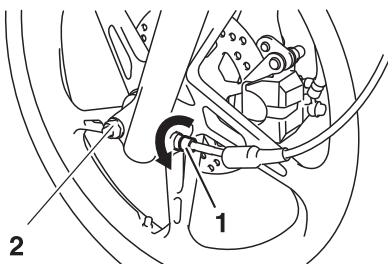

1. Speedometer cable
2. Axle nut and washer

To remove the front wheel

⚠ WARNING

To avoid injury, securely support the vehicle so there is no danger of it falling over.

1. Place the motorcycle on the centerstand.
2. Disconnect the speedometer cable from the front wheel.
3. Remove the axle nut, and the washer.

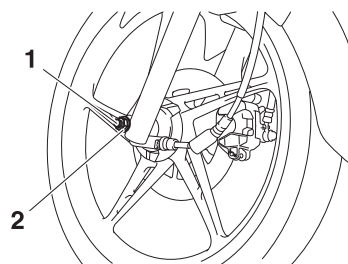

1. Speedometer cable
2. Axle nut and washer

4. Pull the wheel axle out, and then remove the wheel. **NOTICE: Do not apply the brake after the wheel has been removed together with the brake disc, otherwise the brake pads will be forced shut.**

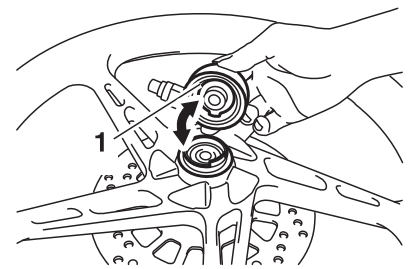

1. Speedometer gear unit

To install the front wheel

1. Install the speedometer gear unit into the wheel hub so that the projection on the wheel hub fits in either slot of the speedometer gear unit.
2. Lift the wheel up between the fork legs.

TIP :

Make sure that there is enough space between the brake pads before inserting the brake disc and that the retainer in the speedometer gear unit fits over the slot on the fork leg.

6-36

PERIODIC MAINTENANCE AND MINOR REPAIR

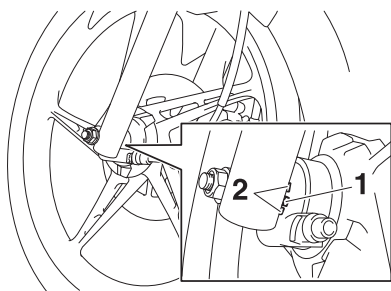

1. Retainer
2. Slot

6

3. Insert the wheel axle, and then install the washer and the axle nut.
4. Take the motorcycle off the center-stand so that the front wheel is on the ground.
5. Tighten the axle nut to the specified torque.

Tightening torque:

Axle nut:
40 Nm (4.0 m·kgf, 29 ft·lbf)

TIP: _____
When tightening the axle nut, hold the wheel axle with a wrench to keep it from turning.

6. While applying the front brake, push down hard on the handlebars several times to check if the front fork compresses and rebounds smoothly.
7. Connect the speedometer cable.

Rear wheel

To remove the rear wheel

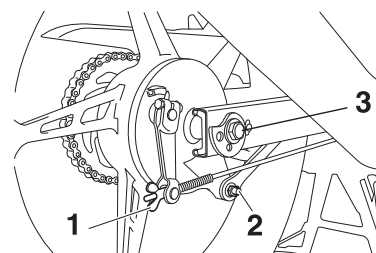

1. Brake pedal free play adjusting nut
2. Brake torque rod nut and bolt
3. Axle nut

⚠ WARNING

- It is advisable to have a Yamaha dealer service the wheel.
- Securely support the motorcycle so that there is no danger of it falling over.

1. Loosen the axle nut.
2. Remove the brake pedal free play adjusting nut, and then disconnect the brake rod from the brake camshaft lever.

6-37

PERIODIC MAINTENANCE AND MINOR REPAIR

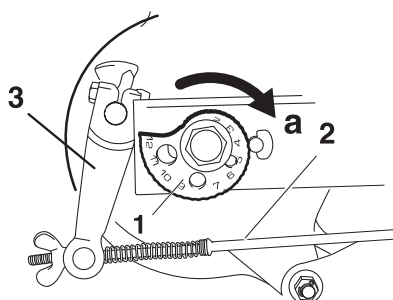

1. Chain adjusting plate
2. Brake rod
3. Brake camshaft lever

3. Turn the drive chain adjusting plate on each side of the swingarm fully in direction (a)
4. Lift the rear wheel off the ground according to the procedure.
5. Remove the axle nut, and then pull the wheel axle out.
6. Push the wheel forward, and then remove the drive chain from the rear sprocket.

TIP: _____
The drive chain does not need to be disassembled in order to remove and install the wheel.

7. Remove the wheel.

To install the rear wheel

1. Install the drive chain onto the rear sprocket.
2. Install the wheel by inserting the wheel axle from the right-hand side.

TIP: _____
Make sure chain adjusting plate is installed onto the wheel axle before installing the wheel axle.

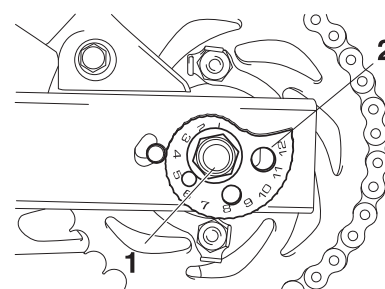

1. Axle nut
2. Chain adjusting plate

3. Install the adjusting plate and the axle nut.
4. Install the brake rod onto the brake camshaft lever, and then install the brake pedal free play adjusting nut onto the brake rod.
5. Connect the brake torque rod to the brake shoe plate by installing the bolt, the washer and the nut.
6. Adjust the drive chain slack. (See page 6-26.)

6

6-38

PERIODIC MAINTENANCE AND MINOR REPAIR

7. Take the motorcycle off the center-stand so that the rear wheel is on the ground.
8. Tighten the brake torque rod nut and axle nut to the specified torques.

TIP: _____
When tightening the axle nut, hold the wheel axle with a wrench to keep it from turning.

Tightening torques:
Brake torque rod nut:
19 Nm (1.9 m·kgf, 14 ft·lbf)
Axle nut:
60 Nm (6.0 m·kgf, 43 ft·lbf)

9. Insert a new cotter pin.
10. Adjust the brake pedal free play. (See page 6-22.)

WARNING

After adjusting the brake pedal free play, check the operation of the brake light.

Troubleshooting

Although Yamaha motorcycles receive a thorough inspection before shipment from the factory, trouble may occur during operation. Any problem in the fuel, compression, or ignition systems, for example, can cause poor starting and loss of power.

The following troubleshooting charts represent quick and easy procedures for checking these vital systems yourself. However, should your motorcycle require any repair, take it to a Yamaha dealer, whose skilled technicians have the necessary tools, experience, and know-how to service the motorcycle properly.

Use only genuine Yamaha replacement parts. Imitation parts may look like Yamaha parts, but they are often inferior, have a shorter service life and can lead to expensive repair bills.

PERIODIC MAINTENANCE AND MINOR REPAIR

Troubleshooting charts

Starting problems or poor engine performance

WARNING

Keep away open flames and do not smoke while checking or working on the fuel system.

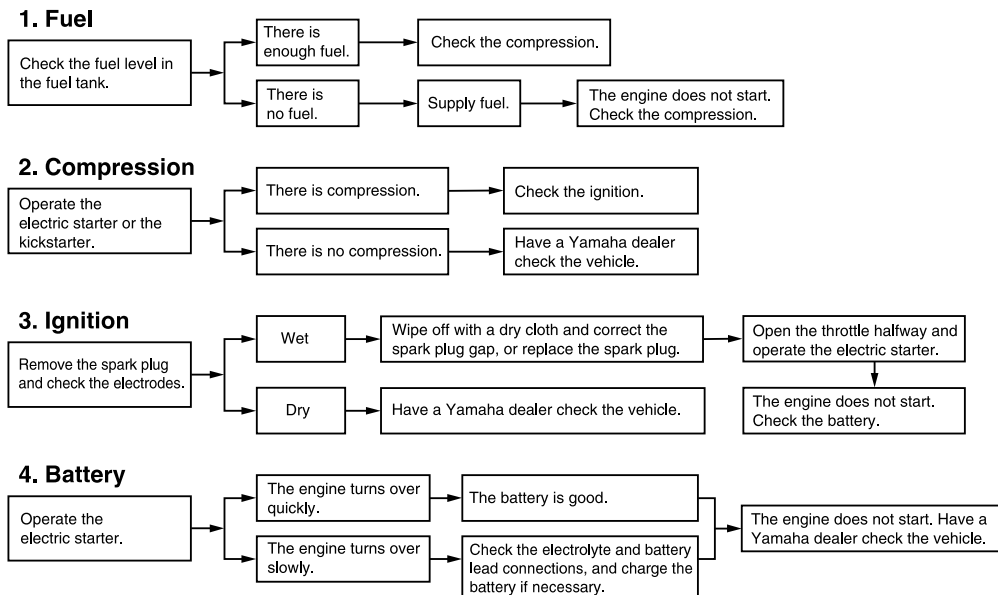

PERIODIC MAINTENANCE AND MINOR REPAIR

Engine overheating

⚠ WARNING

- Do not remove the radiator cap when the engine and radiator are hot. Scalding hot fluid and steam may be blown out under pressure, which could cause serious injury. Be sure to wait until the engine has cooled.
- After removing the radiator cap retaining bolt, place a thick rag, like a towel, over the radiator cap, and then slowly rotate the cap counterclockwise to the detent to allow any residual pressure to escape. When the hissing sound has stopped, press down on the cap while turning it counterclockwise, and then remove the cap.

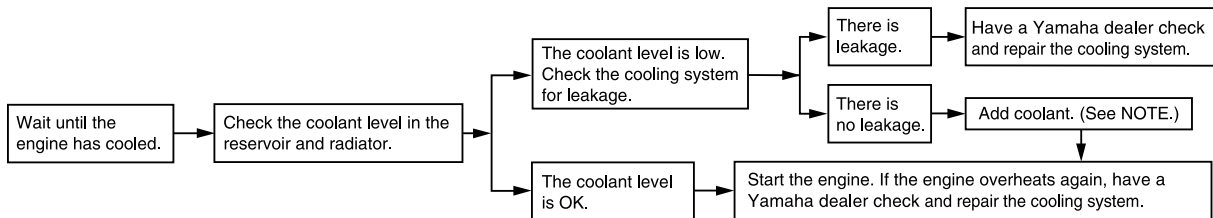

6

TIP:

If coolant is not available, tap water can be temporarily used instead, provided that it is changed to the recommended coolant as soon as possible.

6-41

MOTORCYCLE CARE AND STORAGE

Care

While the open design of a motorcycle reveals the attractiveness of the technology, it also makes it more vulnerable. Rust and corrosion can develop even if high-quality components are used. A rusty exhaust pipe may go unnoticed on a car, however, it detracts from the overall appearance of a motorcycle. Frequent and proper care does not only comply with the terms of the warranty, but it will also keep your motorcycle looking good, extend its life and optimize its performance.

Before cleaning

1. Cover the muffler outlet with a plastic bag after the engine has cooled down.
2. Make sure that all caps and covers as well as all electrical couplers and connectors, including the spark plug cap, are tightly installed.
3. Remove extremely stubborn dirt, like oil burnt onto the crankcase, with a degreasing agent and a brush, but never apply such prod-

ucts onto seals, gaskets, sprockets, the drive chain and wheel axles. Always rinse the dirt and degreaser off with water.

Cleaning

NOTICE

- Avoid using strong acidic wheel cleaners, especially on spoked wheels. If such products are used on hard-to-remove dirt, do not leave the cleaner on the affected area any longer than instructed. Also, thoroughly rinse the area off with water, immediately dry it, and then apply a corrosion protection spray.
- Improper cleaning can damage windshields, cowlings, panels and other plastic parts. Use only a soft, clean cloth or sponge with mild detergent and water to clean plastic.
- Do not use any harsh chemical products on plastic parts. Be sure to avoid using cloths or sponges which have been in contact with strong or abrasive

cleaning products, solvent or thinner, fuel (gasoline), rust removers or inhibitors, brake fluid, antifreeze or electrolyte.

- Do not use high-pressure washers or steam-jet cleaners since they cause water seepage and deterioration in the following areas: seals (of wheel and swing-arm bearings, fork and brakes), electric components (couplers, connectors, instruments, switches and lights), breather hoses and vents.
- For motorcycles equipped with a windshield: Do not use strong cleaners or hard sponges as they will cause dulling or scratching. Some cleaning compounds for plastic may leave scratches on the windshield. Test the product on a small hidden part of the windshield to make sure that it does not leave any marks. If the windshield is scratched, use a quality plastic polishing compound after washing.

7

7-1

MOTORCYCLE CARE AND STORAGE

After normal use

Remove dirt with warm water, a mild detergent, and a soft, clean sponge, and then rinse thoroughly with clean water. Use a toothbrush or bottlebrush for hard-to-reach areas. Stubborn dirt and insects will come off more easily if the area is covered with a wet cloth for a few minutes before cleaning.

After riding in the rain, near the sea or on salt-sprayed roads

Since sea salt or salt sprayed on roads during winter are extremely corrosive in combination with water, carry out the following steps after each ride in the rain, near the sea or on salt-sprayed roads.

TIP:

Salt sprayed on roads in the winter may remain well into spring.

1. Clean the motorcycle with cold water and a mild detergent, after the engine has cooled down.

NOTICE

Do not use warm water since it increases the corrosive action of the salt.

2. Apply a corrosion protection spray on all metal, including chrome- and nickel-plated, surfaces to prevent corrosion.

After cleaning

1. Dry the motorcycle with a chamois or an absorbing cloth.
2. Immediately dry the drive chain and lubricate it to prevent it from rusting.
3. Use a chrome polish to shine chrome, aluminum and stainless-steel parts, including the exhaust system. (Even the thermally induced discoloring of stainless-steel exhaust systems can be removed through polishing.)

4. To prevent corrosion, it is recommended to apply a corrosion protection spray on all metal, including chrome- and nickel-plated, surfaces.
5. Use spray oil as a universal cleaner to remove any remaining dirt.
6. Touch up minor paint damage caused by stones, etc.
7. Wax all painted surfaces.
8. Let the motorcycle dry completely before storing or covering it.

WARNING

- **Make sure that there is no oil or wax on the brakes or tires. If necessary, clean the brake discs and brake linings with a regular brake disc cleaner or acetone, and wash the tires with warm water and a mild detergent.**
- **Before operating the motorcycle test its braking performance and cornering behavior.**

7-2

MOTORCYCLE CARE AND STORAGE

NOTICE

- **Apply spray oil and wax sparingly and make sure to wipe off any excess.**
- **Never apply oil or wax to any rubber and plastic parts, but treat them with a suitable care product.**
- **Avoid using abrasive polishing compounds as they will wear away the paint.**

TIP:

Consult a Yamaha dealer for advice on what products to use.

Storage

Short-term

Always store your motorcycle in a cool, dry place and, if necessary, protect it against dust with a porous cover.

NOTICE

- **Storing the motorcycle in a poorly ventilated room or covering it with a tarp, while it is still wet, will allow water and humidity to seep in and cause rust.**
- **To prevent corrosion, avoid damp cellars, stables (because of the presence of ammonia) and areas where strong chemicals are stored.**

Long-term

Before storing your motorcycle for several months:

1. Follow all the instructions in the "Care" section of this chapter.
2. For motorcycles equipped with a fuel cock that has an "OFF" position: Turn the fuel cock lever to "OFF".
3. Drain the carburetor float chamber by loosening the drain bolt; this will prevent fuel deposits from building up. Pour the drained fuel into the fuel tank.
4. Fill up the fuel tank and add fuel stabilizer (if available) to prevent the fuel tank from rusting and the fuel from deteriorating.

7-3

MOTORCYCLE CARE AND STORAGE

5. Perform the following steps to protect the cylinder, piston rings, etc. from corrosion.
- Remove the spark plug cap and spark plug.
 - Pour a teaspoonful of engine oil into the spark plug bore.
 - Install the spark plug cap onto the spark plug, and then place the spark plug on the cylinder head so that the electrodes are grounded. (This will limit sparking during the next step.)
 - Turn the engine over several times with the starter. (This will coat the cylinder wall with oil.)
 - Remove the spark plug cap from the spark plug, and then install the spark plug and the spark plug cap.

⚠ WARNING

To prevent damage or injury from sparking, make sure to ground the spark plug electrodes while turning the engine over.

- Lubricate all control cables and the pivoting points of all levers and pedals as well as of the side-stand/centerstand.
- Check and, if necessary, correct the tire air pressure, and then lift the motorcycle so that both of its wheels are off the ground. Alternatively, turn the wheels a little every month in order to prevent the tires from becoming degraded in one spot.
- Cover the muffler outlet with a plastic bag to prevent moisture from entering it.
- Remove the battery and fully charge it. Store it in a cool, dry place and charge it once a month. Do not store the battery in an excessively cold or warm place [less than 0 °C (30 °F) or more than 30

°C (90 °F)]. For more information on storing the battery, see page 6-28.

TIP: Make any necessary repairs before storing the motorcycle.

7-4

7

SPECIFICATIONS

Dimensions:

- Overall length: 1960 mm (77.2 in)
- Overall width: 695 mm (27.4 in)
- Overall height: 1080 mm (42.5 in)
- Seat height: 775 mm (30.5 in)
- Wheelbase: 1255 mm (49.4 in)
- Ground clearance: 130 mm (5.12 in)
- Minimum turning radius: 1930 mm (76.0 in)

Weight:

- With oil and fuel: 111 kg (245 lb)

Engine:

- Engine type: Liquid cooled 4-stroke, SOHC
- Cylinder arrangement: Forward-inclined single cylinder
- Displacement: 134 cm³ (8.20 cu.in)
- Bore ? stroke: 54.0 ? 58.7 mm (2.13 ? 2.31 in)
- Compression ratio: 10.90 :1
- Starting system: Electric starter and kickstarter
- Lubrication system: Wet sump

Engine oil:

- Type: YAMALUBE 4T SJ 20W-50 MA or SAE20W40 or SAE20W50
- Recommended engine oil grade: API service SF, SG type or higher JASO MA
- Engine oil quantity:
 - Without oil filter element replacement: 0.80 L (0.85 US qt) (0.70 Imp.qt)
 - With oil filter element replacement: 0.90 L (0.95 US qt) (0.79 Imp.qt)

Cooling system:

- Coolant reservoir capacity (maximum level) YAMAHA GENUINE COOLANT: 0.28 L (0.30 US qt) (0.25 Imp.qt)
- Radiator capacity (including all routes): 0.62 L (0.66 US qt) (0.55 Imp.qt)

Air filter:

- Air filter element: Dry element

Fuel:

- Recommended fuel: Regular unleaded gasoline only
- Fuel tank capacity: 4.0 L (1.06 US gal) (0.88 Imp.gal)

Carburetor:

- Manufacturer: MIKUNI
- Type ? quantity: BS25 x 1

Spark plug (s):

- Manufacturer/model: NGK CPR8EA-9/ DENSO U24EPR-9
- Spark plug gap: 0.8–0.9 mm (0.031–0.035 in)

Clutch:

- Clutch type: Wet, multiple-disc and centrifugal automatic

Transmission:

- Primary reduction system: Spur gear
- Primary reduction ratio: 69/24 (2.875)
- Secondary reduction system: Chain drive
- Secondary reduction ratio: 39/15 (2.600)
- Transmission type: Constant mesh 4-speed
- Operation: Left foot operation
- Gear ratio:
 - 1st: 34/12 (2.833)
 - 2nd: 30/16 (1.875)
 - 3rd: 23/17 (1.353)
 - 4th: 23/22 (1.045)

8-1

8

SPECIFICATIONS

Chassis:

Frame type:
Diamond
Caster angle:
25,60 °
Trail:
80.0 mm (3.1 in)

Front tire:

Type:
Tubeless
Size:
70/90-17M/C 38P
Manufacturer/model:
Vee Rubber/V322F

Rear tire:

Type:
Tubeless
Size:
80/90-17M/C 44P
Manufacturer/model:
Vee Rubber/V322F

Loading:

Maximum load:
150 kg (331 lb)
(Total weight of rider, passenger, cargo and accessories)

Tire air pressure (measured on cold tires):

Loading condition:
0–90 kg (0–198 lb)
Front:
200 kPa (29 psi) (2.00 kgf/cm²)
Rear:
225 kPa (33 psi) (2.25 kgf/cm²)
Loading condition:
90–150 kg (198–331 lb)
Front:
200 kPa (29 psi) (2.00 kgf/cm²)
Rear:
225 kPa (33 psi) (2.25 kgf/cm²)

Front wheel:

Wheel type:
Cast wheel
Rim size:
17x1.40

Rear wheel:

Wheel type:
Cast wheel
Rim size:
17x1.60

Front brake:

Type:
Single disc brake
Operation:
Right hand operation
Recommended fluid:
DOT 3 or 4

Rear brake:

Type:
Drum brake
Operation:
Right foot operation

Front suspension:

Type:
Telescopic fork
Spring/shock absorber type:
Coil spring/oil damper
Wheel travel:
100.0 mm (3.94 in)

Rear suspension:

Type:
Swingarm (monocross)
Spring/shock absorber type:
Coil spring/oil damper
Wheel travel:
90.0 mm (3.54 in)

Electrical system:

Ignition system:
DC. CDI
Charging system:
AC magnet

Battery:

Model:
GTZ 5
Voltage, capacity:
12 V, 3.5 Ah

Headlight:

Bulb type:
Krypton bulb

8-2

8

SPECIFICATIONS

Bulb voltage, wattage x quantity:

Headlight:
12 V, 32 W/32.0 W x 1
Tail/brake light:
12 V, 3.0 W x 1
Front turn signal light:
12 V, 10.0 W x 2
Rear turn signal light:
12 V, 10.0 W x 2
Auxiliary light:
12 V, 0.8 W x 2
Meter lighting:
12 V, 1.7 W x 2
Neutral indicator light:
12 V, 1.7 W x 1
Gear position indicator light:
12 V, 1.7 W x 4
High beam indicator light:
12 V, 1.7 W x 1
Turn signal indicator light:
12 V, 3.0 W x 2
Coolant temperature warning light:
12 V, 1.7 W x 1

Fuse:

Fuse:
10.0 A

8

8-3

CONSUMER INFORMATION

Identification numbers

Record the key identification number, vehicle identification number and engine serial number in the spaces provided below for assistance when ordering spare parts from a Yamaha dealer or for reference in case the vehicle is stolen.

KEY IDENTIFICATION NUMBER:

VEHICLE IDENTIFICATION NUMBER:

ENGINE SERIAL NUMBER:

Key identification number

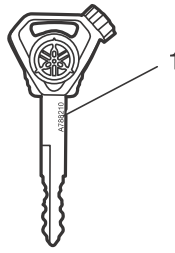

1. Key identification number

The key identification number is stamped into the key. Record this number in the space provided and use it for reference when ordering a new key.

Vehicle identification number

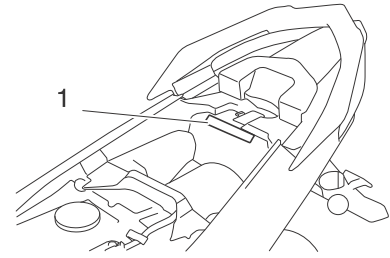

1. Vehicle identification number

The vehicle identification number is stamped into the rear frame.

TIP: _____
The vehicle identification number is used to identify your vehicle and may be used to register it with the licensing authority in your area.

CONSUMER INFORMATION

Engine serial number

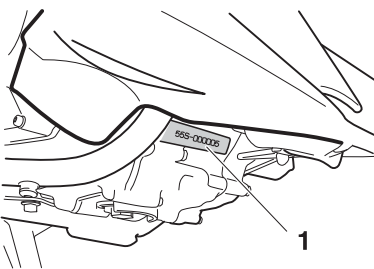

1. Engine serial number

The engine serial number is stamped into the crankcase.

YAMALUBE®



Pelincir Tulen Yamaha



PELINCIR MOTOSIKAL BERPRESTASI TINGGI